

01

# VÁLVULAS INDUSTRIALES INDUSTRIAL VALVES

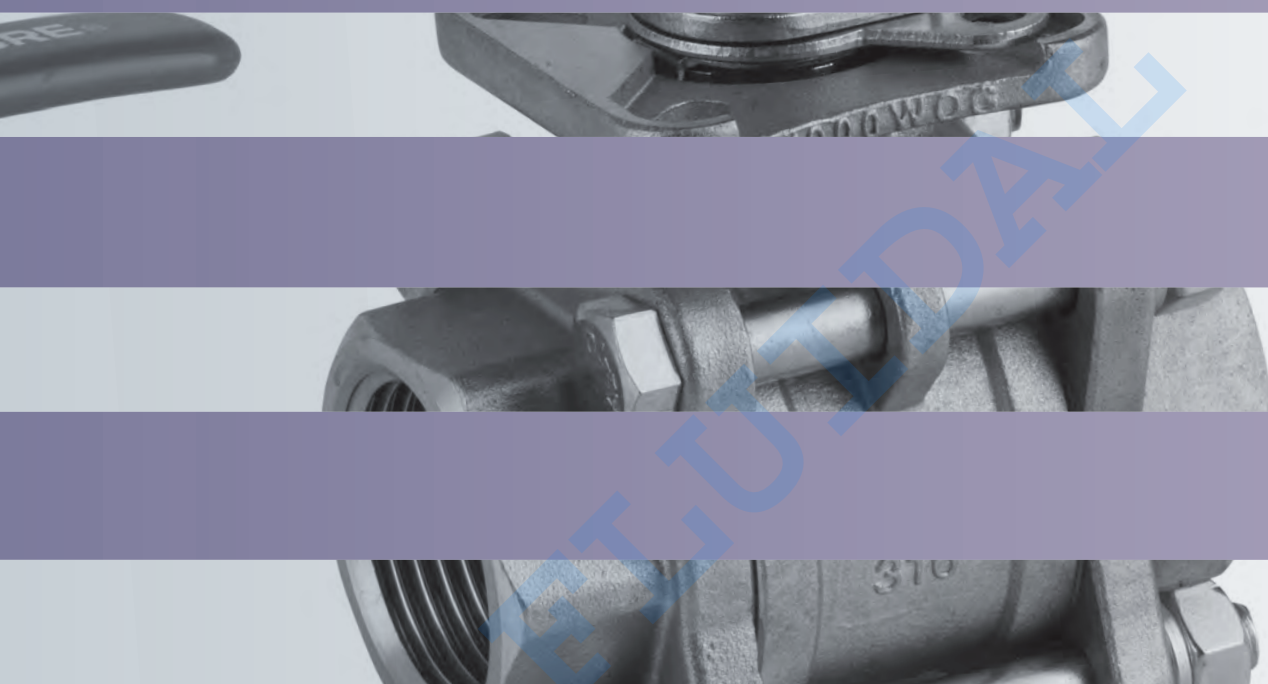

**Selección completa de válvulas y accesorios  
para el control de fluidos, en sus diferentes  
tipologías y de diferentes materiales como  
acero inoxidable, acero al carbono, ...**

A complete selection of valves and accessories  
for fluid control, using various materials such as  
stainless steel, carbon steel, etc.

## VÁLVULAS INDUSTRIALES INDUSTRIAL VALVES

### FACTORES DE CONVERSIÓN CONVERSION FACTORS

#### PRESIÓN PRESSURE

	Kg / cm <sup>2</sup>	PSI	Bar
Kg / cm <sup>2</sup>	1	14,22	0,980665
PSI	0,070307	1	0,06895
Bar	1,0197	14,5038	1

#### TEMPERATURA TEMPERATURE

	°C	°F
°C	1	32+(1.8 x °C)
°F	°F - 32 / 1.8	1

### EXPRESIÓN DE LA PÉRDIDA DE CARGA LOST CHARGE EXPRESSION

**Q** = Caudal circulante (en m<sup>3</sup>/h)  
Medium flow (in m<sup>3</sup>/h)

**Kv** = Coeficiente de caudal o de forma de cada válvula  
Valve flow or shape coefficient

**Δp** = Pérdida de carga (en bar)  
Head losses (in bar)

**ρ** = Masa específica (en Kg/m<sup>3</sup>)  
Medium density (in Kg/m<sup>3</sup>)

$$Q = Kv \sqrt{\frac{\Delta p}{\rho}}$$

### CÁLCULO DE LA VELOCIDAD / CALCULATION OF THE SPEED

**V** = Velocidad de circulación (en m/s)  
Circulation speed (in m/s)

**Q** = Caudal (en m<sup>3</sup>/h)  
Flow (in m<sup>3</sup>/h)

**D** = Diámetro de paso (en mm)  
Bore diameter (in mm)

$$V = 353,7 \frac{Q}{D^2}$$

**Ref. 2001**



**Válvula esfera paso reducido 1 pieza**  
 Const.: AISI 316 pulido. FV. Asientos PTFE. Extremos:  
 Rosca gas ISO 7-1 (EN 10226-1). PN 63 Temp. -25°C +180°C.  
 Mando manual por palanca.

**1 pc reduced bore ball valve**  
 Constr.: polished AISI 316 Seats PTFE. Gas threaded.  
 Ends ISO 7-1 (EN 10226-1). PN 63 Temp. -25°C +180°C.  
 Manually operated by handle

Medida/Size	P	A	L	M
1/4"	5	31	40	65
3/8"	7	36	45	85
1/2"	9	41	57	95

CÓDIGO CODE	MEDIDA SIZE	PESO WEIGHT	CAJA / BOX CARTON	P.V.P. € PRICE €
-------------	-------------	-------------	-------------------	------------------

2001 02	1/4"	0,070	40-320	-
2001 03	3/8"	0,108	20-160	-
2001 04	1/2"	0,184	15-120	-

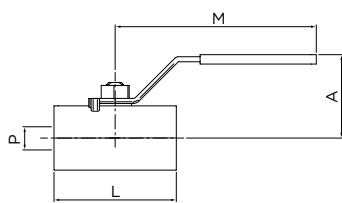

**Ref. 2002 - 2004**



**Válvula esfera paso reducido 1 pieza**  
 Art. 2002 rosca NPT ASME B1.20.1  
 Art. 2004 rosca gas ISO 7-1 (EN 10226-1).  
 Const. acero inox CF8M (316) Microfusión. Asientos:  
 PTFE PN 63 temp. -25°C +180°C. Mando manual  
 por palanca. Con sistema de bloqueo.

**1 pc reduced bore ball valve**  
 Art. 2002 NPT thread ASME B1.20.1  
 Art. 2004 gas ISO 7-1 (EN 10226-1) thread  
 Const. stainless steel CF8M (316). Investment. Casting.  
 Seats: PTFE PN 63 temp. -25°C + 180°C.  
 Manually operated by handle.  
 With locking system.

Medida/Size	P	A	L	M
1/4"	4,6	32	39	60
3/8"	6,8	36	44	80
1/2"	9,2	42	56	87
3/4"	12,5	45	59	87
1"	15	50	69	105
1 1/4"	20	54	77	105
1 1/2"	25	70	81	125
2"	32	78	97	140

2002 02	1/4"	0,065	40-320	-
2002 03	3/8"	0,108	20-160	-
2002 04	1/2"	0,180	15-120	-
2002 05	3/4"	0,257	10-80	-
2002 06	1"	0,373	5-40	-
2002 07	1 1/4"	0,587	4-32	-
2002 08	1 1/2"	0,820	4-32	-
2002 09	2"	1,230	1-8	-
2004 02	1/4"	0,065	40-320	-
2004 03	3/8"	0,102	20-160	-
2004 04	1/2"	0,175	15-120	-
2004 05	3/4"	0,235	10-80	-
2004 06	1"	0,382	5-40	-

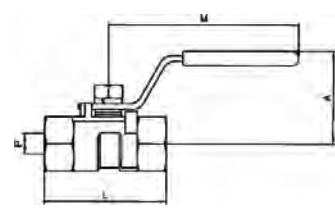

**Ref. 2005**



**Válvula esfera paso reducido 1 pieza M-H**  
 Const: AISI 316 pulido - asientos PTFE  
 Extremos rosca gas M - H ISO 7-1 (EN 10226-1). PN 63.  
 Temp. -25°C + 180°C. Mando manual.

**1 pc reduced bore ball valve M-F**  
 Const. polished stainless steel AISI 316. M-F gas  
 threaded ends. ISO 7-1 (EN 10226-1) PN 63. Seats: PTFE.  
 Temp. -25°C +180°C manually operated.

Medida/Size	P	A	L	M
1/4"	8	26	40	22
3/8"	8	26	40	22
1/2"	10	28	46	22
3/4"	12	34	54	22
1"	15	34	65	22

2005 02	1/4"	0,076	20-240	-
2005 03	3/8"	0,082	20-240	-
2005 04	1/2"	0,116	20-240	-
2005 05	3/4"	0,177	15-180	-
2005 06	1"	0,342	6-72	-

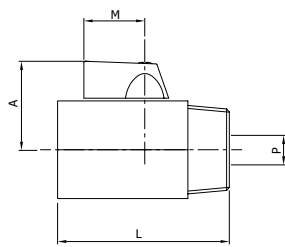

**Ref. 2006**



**Válvula esfera paso reducido 1 pieza H-H**  
 Const: AISI 316 pulido - Asientos PTFE  
 Extremos rosca gas ISO 7-1 (EN 10226-1). PN 63  
 PN-63. Temp. -25°C +180°C. Mando manual.

**1 pc reduced bore ball valve F-F**  
 Const. polished stainless steel AISI 316.  
 Seats: PTFE. F-F gas ISO 7-1 (EN 10226-1) threaded ends. PN 63  
 Temp. -25°C +180°C. Manually operated.

Medida/Size	P	A	L	M
1/4"	8	26	40	22
3/8"	8	26	40	22
1/2"	10	28	46	22
3/4"	12	34	54	22
1"	15	34	65	22

2006 02	1/4"	0,091	20-240	-
2006 03	3/8"	0,082	20-240	-
2006 04	1/2"	0,116	15-180	-
2006 05	3/4"	0,211	15-180	-
2006 06	1"	0,358	6-72	-

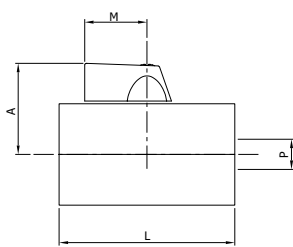

# LÍNEA INDUSTRIAL / INDUSTRIAL LINE

01 VÁLVULAS INDUSTRIALES INDUSTRIAL VALVES

**Ref. 2007 - 2007N**



**Válvula de esfera paso total Alta Presión**  
Rosca BSP, también disponible con rosca NPT (2007N).  
Const.: acero al carbono ASTM A105.  
Esfera y eje inoxidable 304. Asientos PEEK.  
Serie 1500 (255 bar) - Temp. -30°C +250°C.

**High Pressure full bore ball valve**  
BSP thread, also available whit NPT thread (2007N).  
Const. carbon steel ASTM A105.  
Ball and stem: stainless steel 304. Seats: PEEK.  
Class 1500 (255 bar) - Temp. -30°C +250°C.

Medida/Size	A	M	L
1/4"	70	155	65
3/8"	70	155	65
1/2"	74	155	76
3/4"	87	180	91
1"	92	180	100

CÓDIGO CODE	MEDIDA SIZE	PESO WEIGHT	CAJA / BOX CARTON	P.V.P. € PRICE €
-------------	-------------	-------------	-------------------	------------------

2007 02	1/4"	0,500	6-30	-
2007 03	3/8"	0,500	6-30	-
2007 04	1/2"	0,900	6-30	-
2007 05	3/4"	1,553	4-12	-
2007 06	1"	2,219	4-12	-

Precios rosca NPT a consultar / NPT thread prices on request

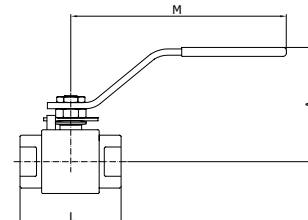

**Ref. 2008**



**Válvula esfera paso standard 2 piezas**  
Const.: acero inox. CF8M (316) microfusión. Juntas y asientos: PTFE+PV  
extremos: rosca gas ISO 7-1 (EN 10226-1). PN 140 temp. -25°C +180°C. Mando manual por palanca con sistema de bloqueo.

**2 pcs standard bore ball valve**  
Const: stainless steel CF8M (316). Investment casting. Seats and seals: PTFE + GF ends: gas threaded ends ISO 7-1 (EN 10226-1). PN 140. Temp -25°C +180°C. Manually operated by handle with locking system.

Medida/Size	P	A	L	M
1/4"	9,5	42	54	105
3/8"	9,5	42	54	105
1/2"	13	46	61,5	105
3/4"	17,5	53	72	147
1"	22	58	84,5	147
1 1/4"	25,4	68	92	168
1 1/2"	31,7	72	103	193
2"	38,1	78	118	193

2008 02	1/4"	0,219	12-72	-
2008 03	3/8"	0,220	12-72	-
2008 04	1/2"	0,304	12-72	-
2008 05	3/4"	0,581	5-30	-
2008 06	1"	0,809	5-30	-
2008 07	1 1/4"	1,060	2-12	-
2008 08	1 1/2"	1,668	6-12	-
2008 09	2"	2,552	4-8	-

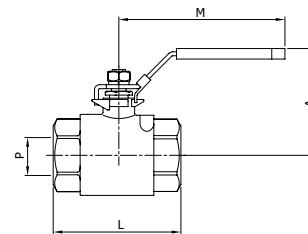

**Ref. 2009**



**Válvula esfera paso total 2 piezas**  
Const.: acero inox. CF8M (316) microfusión. Extremos H-H rosca gas ISO 7-1 (EN 10226-1). Asientos PTFE + 15%. FV tórica eje viton. PN 63. Temp. -25°C +180°C. Mando manual por palomilla.

**2 pcs full bore ball valve**  
Const: stainless steel CF8M (316). Investment casting. Gas threaded F-F ISO 7-1 (EN 10226-1). Seats: PTFE + 15% GF. O'ring stem: viton. PN 63. Temp. -25°C. +180°C. Butterfly handle.

Medida/Size	A	L	M
1/4"	38	50	50
3/8"	38	50	50
1/2"	41	55	50
3/4"	58	70	63
1"	61	83	63

2009 02	1/4"	0,187	15-180	-
2009 03	3/8"	0,180	15-180	-
2009 04	1/2"	0,217	10-120	-
2009 05	3/4"	0,432	6-72	-
2009 06	1"	0,593	4-48	-

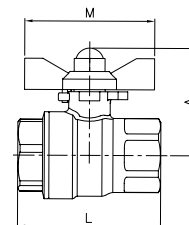

**Ref. 2010**



**Válvula esfera paso total 2 piezas**  
Const.: acero inox. CF8M (316) microfusión. Extremos M-H rosca gas ISO 7-1 (EN 10226-1). Asientos PTFE + 15%. FV tórica eje viton. PN 63. Temp. -25°C. +180°C. Mando manual por palomilla.

**2 pcs full bore ball valve**  
Const: stainless steel CF8M (316). Investment casting. Gas threaded M-F ISO 7-1 (EN 10226-1). Seats: PTFE + 15% GF O'ring stem: viton. PN 63. Temp. -25°C. +180°C. Butterfly handle.

Medida/Size	A	L	M
1/4"	32	56	50
3/8"	32	56	50
1/2"	41	63	50
3/4"	58	80	63
1"	61	91	63

2010 02	1/4"	0,187	10-120	-
2010 03	3/8"	0,176	10-120	-
2010 04	1/2"	0,224	8-96	-
2010 05	3/4"	0,443	6-72	-
2010 06	1"	0,608	4-48	-

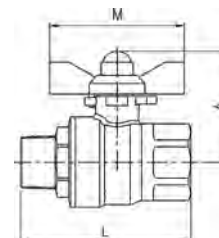

**Ref. 2011**



**Válvula esfera paso total 2 piezas**  
 Const.: acero inox. CF8 (304) microfundición. Extremos: rosca gas ISO 7-1 (EN 10226-1). Asientos: PTFE + 15% FV. Tórica eje Viton. PN 40, Temp: -25°C +180°C. Mando manual por palanca con sistema de bloqueo (NC).

**2 pcs full bore ball valve**  
 Const. stainless steel CF8 (304) investment casting. Gas threaded ends ISO 7-1 (EN 10226-1). Seats: PTFE + 15% GF. O'ring Stem: viton. PN 40. Temp: -25°C +180°C. Manually operated by handle with locking system (NC).

Medida/Size	A	L	M
1/2"	50	48	104
3/4"	60	59	122
1"	63	70	122

CÓDIGO CODE	MEDIDA SIZE	PESO WEIGHT	CAJA / BOX CARTON	P.V.P. € PRICE €
-------------	-------------	-------------	-------------------	------------------

2011 04	1/2"	0,163	10-120	-
2011 05	3/4"	0,294	6-72	-
2011 06	1"	0,445	4-48	-

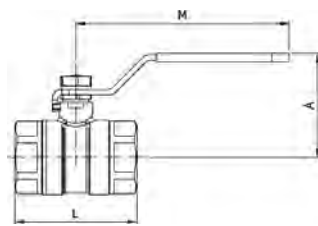

**Ref. 2013**



**Válvula esfera paso total 2 piezas**  
 Construcción: acero inox. CF8M (316) microfundición. Extremos: M-H rosca gas ISO 7-1 (EN 10226-1). Asientos: PTFE + 15% FV. Tórica eje Viton. PN 63, Temperatura: -25°C +180°C. Mando manual por palanca con sistema de bloqueo.

**2 pcs full bore ball valve**  
 Construction: stainless steel CF8M (316) investment casting. Gas threaded ends M-F ISO 7-1 (EN 10226-1). Seats: PTFE + 15% GF. O'ring stem: viton. PN 63. Temperature: -25°C +180°C. Manually operated by handle with locking system.

Medida/Size	A	L	M
1/4"	50	56	104
3/8"	50	56	104
1/2"	51	63	104
3/4"	62	80	122
1"	65	91	122

2013 02	1/4"	0,201	12-144	-
2013 03	3/8"	0,201	12-144	-
2013 04	1/2"	0,245	10-120	-
2013 05	3/4"	0,457	6-72	-
2013 06	1"	0,623	4-48	-

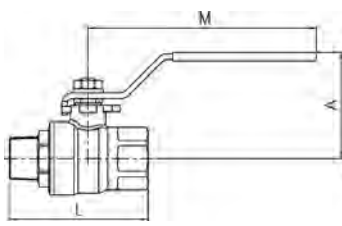

**Ref. 2014 - 2014N**



**Válvula esfera paso total 2 piezas**  
 Rosca BSP, también disponible con rosca NPT (2014N). Const. acero inox. CF8M (316) microfundición. Extremos: rosca gas ISO 7-1 (EN 10226-1). Juntas y asiento: PTFE + 15% FV tórica eje vitón PN 63, Temp: -25°C + 180°C. Mando manual por palanca con sistema de bloqueo.

**2 pcs full bore ball valve**  
 BSP thread, also available with NPT thread (2014N). Const. stainless steel CF8M (316) investment casting. Gas threaded ends ISO 7-1 (EN 10226-1). Seats and seals: PTFE + 15% GF. O'ring stem: viton. PN 63. Temp. -25°C +180°C. Manually operated by handle with locking system.

Medida/Size	A	M	L
1/4"	50	104	50
3/8"	50	104	50
1/2"	51,5	104	55
3/4"	62	122	70
1"	65	122	83
1 1/4"	82	180	91
1 1/2"	88	180	103
2"	106	219	120
2 1/2"	119	230	152
3"	135	275	172

2014 02	1/4"	0,207	12-144	-
2014 03	3/8"	0,205	12-144	-
2014 04	1/2"	0,231	10-120	-
2014 05	3/4"	0,442	6-72	-
2014 06	1"	0,597	4-48	-
2014 07	1 1/4"	1,061	8-16	-
2014 08	1 1/2"	1,500	6-12	-
2014 09	2"	2,698	3-6	-
2014 10	2 1/2"	4,757	2-4	-
2014 11	3"	7,391	1-2	-

Precios rosca NPT a consultar / NPT thread prices on request

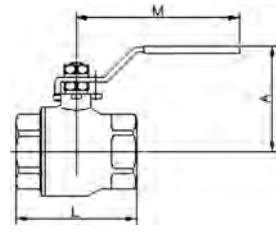

**Ref. 2015**



**Válvula esfera paso total 2 piezas**  
 Const.: AISI 316 - juntas y asientos PTFE+FV extremos: rosca gas ISO 7-1 (EN 10226-1) tórica eje: vitón. PN 63. Temp. -25°C +180°C. Mando manual por palanca. Montaje directo s/ISO 5211con sistema de bloqueo.

**2 pcs full bore ball valve**  
 Const. AISI 316 seats and seals PTFE + GF gas threaded ends ISO 7-1 (EN 10226-1). O'ring stem: viton. PN 63. Temp. -25°C +180°C. Manually operated by handle. Direct assembling ISO 5211with locking system.

Medida/Size	A	M	L	ISO 5211
1/4"	62	112	50	F-03
3/8"	62	112	50	F-03
1/2"	63	112	55	F-03/F-04
3/4"	70	138	70	F-04/F-05
1"	70	160	83	F-04/F-05
1 1/4"	88	160	91	F-05/F-07
1 1/2"	94	205	103	F-05/F-07
2"	100	205	103	F-05/F-07

2015 02	1/4"	0,291	8-96	-
2015 03	3/8"	0,285	8-96	-
2015 04	1/2"	0,330	6-72	-
2015 05	3/4"	0,560	3-36	-
2015 06	1"	0,725	2-24	-
2015 07	1 1/4"	1,334	8-16	-
2015 08	1 1/2"	1,900	6-12	-
2015 09	2"	2,830	3-6	-

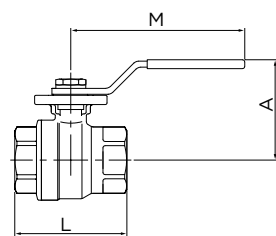

# LÍNEA INDUSTRIAL / INDUSTRIAL LINE

01 VÁLVULAS INDUSTRIALES INDUSTRIAL VALVES

Ref.2016

**NEW**

### Válvula Esfera 2 piezas.

Const.: acero inox. CF8M (316) microfusión. Extremos: Hembra rosca gas ISO 7-1 (EN 10226-1), Macho Camlock. Asientos:PTFE + 15% FV. Tórica eje Viton. PN10. Temp: -25°C +180°C. Mando manual por palanca con sistema de bloqueo.

### 2 pieces Ball valve.

Const. stainless steel CF8M (316) investment casting. Gas Female Threaded ends ISO 7-1 (EN 10226-1), Camlock Male. Seats: PTFE + 15% GF. O'ring Stem: viton. PN10. Temp: -25°C +180°C. Manually operated by handle with locking system



Medida/Size	D	A	L	M	Weight
1/2"	24	51,5	82	104	0,290
3/4"	32	62	96	122	0,540
1"	36,5	65	116	122	0,750
1 1/4"	45,5	82	131	180	1,375
1 1/2"	53,5	88	141	180	1,850
2"	63	106	164	219	3,200
2 1/2"	75,8	119	202	230	5,410
3"	91,5	135	223	275	8,300

CÓDIGO CODE	MEDIDA SIZE	PESO WEIGHT	CAJA / BOX CARTON	P.V.P. € PRICE €
2016 04	1/2"	0,290	-	-
2016 05	3/4"	0,540	-	-
2016 06	1"	0,750	-	-
2016 07	1 1/4"	1,375	-	-
2016 08	1 1/2"	1,850	-	-
2016 09	2"	3,200	-	-
2016 10	2 1/2"	5,410	-	-
2016 11	3"	8,300	-	-

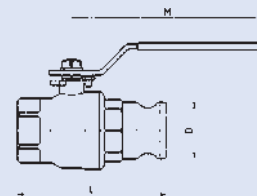

Ref.2025 - 2025N

### Válvula esfera paso total 3 piezas

Rosca BSP (2025), también disponible con rosca NPT (2025N). Const.: acero inox. CF8M (316) microfusión rosca gas ISO 7-1 (EN 10226-1). Juntas y asientos PTFE + 15% FV tórica eje: vitón. PN - 63. Temp. -25°C + 180°C. Montaje directo s/ISO 5211 con sistema de bloqueo.

### 3 pcs full bore ball valve

BSP thread (2025), also available with NPT thread (2025N). Const.: stainless steel CF8M (316) investment casting gas thread ISO 7-1 (EN 10226-1). Seats and seats: PTFE +15% GF o'ring stem: viton PN-63. Temp. -25°C +180°C. Direct assembling ISO 5211 with locking system.



Medida/Size	P	L	A	M	ISO 5211
1/4"	11	47,6	60	112	F-03
3/8"	12,7	47,6	60	112	F-03
1/2"	15	56	60	112	F-03/F-04
3/4"	20	73	70	138	F-04/F-05
1"	25	82	70	138	F-04/F-05
1 1/4"	32	91	88	160	F-05/F-07
1 1/2"	40	104	94	205	F-05/F-07
2"	50	120	100	205	F-05/F-07
2 1/2"	65	155	150	330	F-07/F-10
3"	80	182	165	330	F-07/F-10
4"	100	220	175	340	F-07/F-10

2025 02	1/4"	0,383	8-96	-
2025 03	3/8"	0,370	8-96	-
2025 04	1/2"	0,420	6-72	-
2025 05	3/4"	0,830	3-36	-
2025 06	1"	1,030	2-24	-
2025 07	1 1/4"	1,860	8-16	-
2025 08	1 1/2"	2,510	4-8	-
2025 09	2"	3,610	2-4	-
2025 10	2 1/2"	8,785	1-2	-
2025 11	3"	12,867	1-2	-
2025 12	4"	19,790	1-1	-

Precios rosca NPT a consultar / NPT thread prices on request

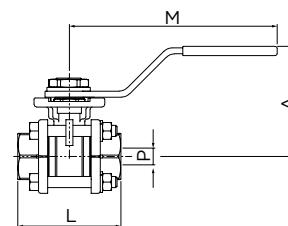

Ref. 2026

### Válvula esfera paso total 3 piezas. Butt weld ANSI B 16.25

Const.: acero inox. CF8M (316) microfusión. Juntas y asientos PTFE+15% FV tórica eje: vitón PN 63. Temp. -25°C +180°C. Mando manual por palanca. Montaje directo S/ ISO 5211 con sistema de bloqueo.

### 3 pcs full bore ball valve. Butt weld ansi b 16.25

Const.: stainless steel CF8M (316) investment casting. Seats and seats: PTFE +15% GF o'ring stem: viton PN 63. Temp. -25°C +180°C. Manually operated by handle. Direct assembling ISO 5211 with locking system.

1000 WOG -13°F + 356°F



Medida/Size	P	L	A	M	T	B	ISO 5211
1/4"	11	47,6	60	112	13	11	F-03
3/8"	12,7	47,6	60	112	14,7	12,7	F-03
1/2"	15	56	60	112	17	15	F-03/F-04
3/4"	20	73	70	138	22	20	F-04/F-05
1"	25	82	70	138	28	25	F-04/F-05
1 1/4"	32	91	88	160	35	32	F-05/F-07
1 1/2"	40	104	94	205	43	40	F-05/F-07
2"	50	120	100	205	54	50	F-05/F-07
2 1/2"	65	155	150	330	69	65	F-07/F-10
3"	80	182	165	330	87	80	F-07/F-10
4"	100	230	175	340	105	100	F-07/F-10

2026 02	1/4"	0,369	8-96	-
2026 03	3/8"	0,362	8-96	-
2026 04	1/2"	0,420	6-72	-
2026 05	3/4"	0,787	3-36	-
2026 06	1"	1,010	2-24	-
2026 07	1 1/4"	1,870	8-16	-
2026 08	1 1/2"	2,440	4-8	-
2026 09	2"	3,472	2-4	-
2026 10	2 1/2"	8,624	1-2	-
2026 11	3"	12,427	1-2	-
2026 12	4"	19,376	1-1	-

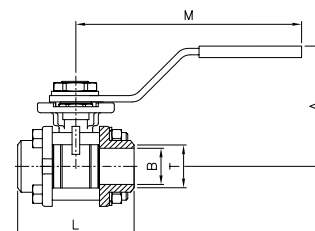

Ref. 2027



**Válvula esfera paso total 3 piezas socket weld ANSI B 16.11**  
 Const.: acero inox. CF8M (316) microfusión. Juntas y asientos PTFE+15% FV  
 tórica eje: vitón. PN 63. Temp. -25°C +180°C mando manual por palanca.  
 Montaje directo s/DIN 5211 con sistema de bloqueo.

**3 pcs full bore ball valve socket weld ANSI B 16.11**  
 Const.: stainless steel CF8M (316) investment casting. Seats and seals: PTFE  
 +15% GF o'ring stem: viton. PN 63. Temp. -25°C +180°C. Manually operated by  
 handle. Direct assembling ISO 5211 with locking system.

Medida/Size	P	L	A	M	S	K	ISO 5211
1/4"	11	47,6	60	112	14,1	10	F-03
3/8"	12,7	47,6	60	112	17,6	10	F-03
1/2"	15	56	60	112	21,7	14	F-03/F-04
3/4"	20	73	70	138	27,1	10	F-04/F-05
1"	25	82	70	138	33,8	14	F-04/F-05
1 1/4"	32	91	88	160	42,6	15	F-05/F-07
1 1/2"	40	104	94	205	48,7	15	F-05/F-07
2"	50	120	100	205	61,1	19	F-05/F-07
2 1/2"	65	155	150	330	73,8	21	F-07/F-10
3"	80	182	165	330	89,8	24	F-07/F-10
4"	100	220	175	340	115,5	35	F-07/F-10

CÓDIGO CODE	MEDIDA SIZE	PESO WEIGHT	CAJA / BOX CARTON	P.V.P. € PRICE €
2027 02	1/4"	0,369	8-96	-
2027 03	3/8"	0,387	8-96	-
2027 04	1/2"	0,424	6-72	-
2027 05	3/4"	0,830	3-36	-
2027 06	1"	0,980	2-24	-
2027 07	1 1/4"	1,876	8-16	-
2027 08	1 1/2"	2,483	4-8	-
2027 09	2"	3,527	2-4	-
2027 10	2 1/2"	8,790	1-2	-
2027 11	3"	12,852	1-2	-
2027 12	4"	19,447	1-1	-

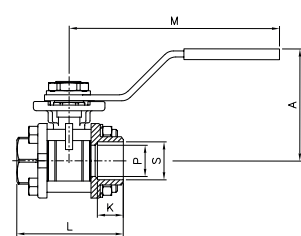

Ref. 2034 - 2034N



**Válvula esfera paso total 3 piezas**  
 Rosca BSP (2034), también disponible con rosca NPT (2034N). Const. acero  
 al carbono "WCB" (microfusión). Esfera y eje inoxidable 316. Rosca gas ISO  
 7-1 (EN 10226-1). Asientos PTFE + 15% FV. 1000 wog. Temp. -25°C +180°C.  
 Mando manual por palanca con sistema de bloqueo.

**3 pcs full bore ball valve**  
 BSP thread (2034), also available with NPT thread (2034N). Const. carbon  
 steel "WCB" (investment casting). Ball and stem: stainless steel 316. Gas  
 thread ISO 7-1 (EN 10226-1). Seats: PTFE + 15% GF. 1000 wog. Temp. -25°C  
 +180°C. Manually operated by handle with locking system.

Medida/Size	A	L	M
1/4"	48	50	100
3/8"	48	50	100
1/2"	50	61	103
3/4"	60	70	127
1"	64	80	127
1 1/4"	79	93	154
1 1/2"	85	102	154
2"	87	124	192
2 1/2"	117	156	244
3"	125	179	244
4"	173	218	330

2034 02	1/4"	0,290	12-72	-
2034 03	3/8"	0,261	12-72	-
2034 04	1/2"	0,360	9-54	-
2034 05	3/4"	0,610	6-36	-
2034 06	1"	0,825	4-24	-
2034 07	1 1/4"	1,438	2-12	-
2034 08	1 1/2"	1,753	4-8	-
2034 09	2"	3,098	3-6	-
2034 10	2 1/2"	6,100	1-4	-
2034 11	3"	9,120	1-2	-
2034 12	4"	19,525	1-1	-

Precios rosca NPT a consultar / NPT thread prices on request

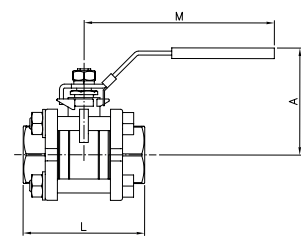

Ref. 2034S



**Válvula esfera paso total 3 piezas socket weld ANSI B 16.11**  
 Const. acero al carbono "WCB" (microfusión). Esfera y eje inoxidable 316.  
 Asientos PTFE + 15% FV. 1000 wog. Temp. -25°C +180°C. Mando manual por  
 palanca con sistema de bloqueo.

**3 pcs full bore ball valve socket weld ANSI B 16.11**  
 Const. carbon steel "WCB" (investment casting). Ball and stem: stainless  
 steel 316. Seats: PTFE + 15% GF. 1000 wog. Temp. -25°C +180°C. Manually  
 operated by handle with locking system.

Medida/Size	A	L	M	S	K
1/4"	48	50	100	14,1	10
3/8"	48	50	100	17,6	10
1/2"	50	61	103	21,7	10
3/4"	60	70	127	33,8	14
1"	64	80	127	33,8	14
1 1/4"	79	93	154	42,6	15
1 1/2"	85	102	154	48,7	15
2"	87	124	192	61,1	19
2 1/2"	117	156	244	73,8	21
3"	125	179	244	89,8	24
4"	173	218	330	115,5	25

2034S 02	1/4"	0,271	12-72	-
2034S 03	3/8"	0,253	12-72	-
2034S 04	1/2"	0,352	9-54	-
2034S 05	3/4"	0,582	6-36	-
2034S 06	1"	0,796	4-24	-
2034S 07	1 1/4"	1,405	2-12	-
2034S 08	1 1/2"	1,725	4-8	-
2034S 09	2"	3,040	3-6	-
2034S 10	2 1/2"	6,371	1-4	-
2034S 11	3"	8,992	1-2	-
2034S 12	4"	19,460	1-1	-

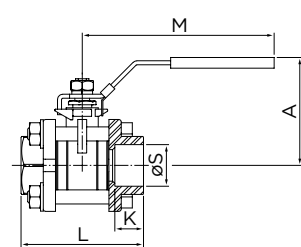

# LÍNEA INDUSTRIAL / INDUSTRIAL LINE

01 VÁLVULAS INDUSTRIALES INDUSTRIAL VALVES

Ref. 2040 - 2041



**Válvula esfera 3 vías paso reducido**  
**Art. 2040: Paso tipo L / Art. 2041: Paso tipo T. También disponible con rosca NPT: 2040N (Tipo L) y 2041N (Tipo T)**  
 Const.: AISI 316 - Cuatro asientos PTFE+FV juntas cuerpo y eje: PTFE tórica eje: Vitón. Extremos: Rosca gas ISO 7-1 (EN 10226-1). PN 63. Temp. -25°C +180°C. Montaje directo S/ISO 5211. Mando manual por palanca con sistema de bloqueo.

**3 Ways ball valve reduced bore**  
**Art. 2040: "L" bore / Art. 2041: "T" bore. Also available with NPT thread: 2040N ("L") y 2041N ("T")**  
 Const.: AISI 316; Four seats PTFE + GF body and stem seats: PTFE o'ring stem: Viton. Gas threaded ends ISO 7-1 (EN 10226-1). PN 63. Temp. -25°C +180°C. Direct assembling S/ISO 5211. Manually operated by handle with locking system.

CÓDIGO CODE	MEDIDA SIZE	PESO WEIGHT	P.V.P. € PRICE €
2040 / 2041			
XXXX 02	1/4"	0,700	-
XXXX 03	3/8"	0,665	-
XXXX 04	1/2"	0,630	-
XXXX 05	3/4"	0,943	-
XXXX 06	1"	1,406	-
XXXX 07	1 1/4"	2,980	-
XXXX 08	1 1/2"	3,810	-
XXXX 09	2"	6,332	-
XXXX 10	2 1/2"	8,910	-

Medida/Size	P	A	B	L	M
1/4"	9,5	66	57,5	75	130
3/8"	11	66	57,5	75	130
1/2"	12	66	57,5	75	130
3/4"	15	72	65,5	85	161
1"	20	77	79	100	161
1 1/4"	25	92	97	122	203
1 1/2"	32	96	106,5	131	203
2"	40	107	129	158	203
2 1/2"	49	135	145	178	254

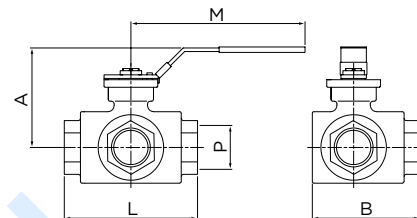

Ref. 2048



**Válvula esfera paso total con record dos piezas**  
 Const.: acero inox. CF8M (316) microfundición. Extremos: M-H rosca gas ISO 7-1 (EN 10226-1). Asientos:PTFE + 15% FV. Tórica eje Viton. PN 63, Temp: -25°C + 180°C. Mando manual por palanca con sistema bloqueo.

**Full bore ball valve with 2 pieces connector**  
 Const. stainless steel CF8M (316) investment casting. Gas Threaded ends M-F ISO 7-1 (EN 10226-1). Seats: PTFE + 15% GF. O'ring Stem: viton. PN 63. Temp: -25°C + 180°C. Manually operated by handle with locking system.

2048 06	1"	0,760	-
2048 07	1 1/4"	1,340	-
2048 08	1 1/2"	1,835	-

Medida/Size	A	L	M
1"	62	110	122
1 1/4"	80	125	180
1 1/2"	85	136	180

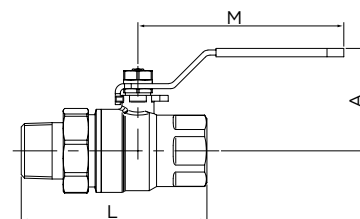

Ref. 2052



**Válvula esfera paso total fondo de cubas**  
 Const. acero inox. CF8M (316) y 316l (fondo de cubas). **Extremo rosca gas ISO 7-1 (EN 10226-1) y fondo de cubas.** Asientos PTFE + 15% FV. Tórica eje vitón. PN 63. Temp. -25°C +180°C. Montaje directo S/ISO 5211. Mando manual por palanca con sistema de bloqueo.

**Tank bottom full bore ball valve**  
 Const. stainless steel CF8M (316) and 316l (tank bottom). **Ends: gas thread ISO 7-1 (EN 10226-1) and tank bottom.** Seats: PTFE + 15% FV. O'ring stem: viton. PN 63. Temp. -25°C +180°C. Direct assembling ISO 5211. Manually operated by handle with locking system.

2052 04	1/2"	0,440	-
2052 05	3/4"	0,820	-
2052 06	1"	1,020	-
2052 07	1 1/4"	1,790	-
2052 08	1 1/2"	2,460	-
2052 09	2"	3,470	-
2052 10	2 1/2"	8,500	-
2052 11	3"	12,400	-
2052 12	4"	19,650	-

Medida/Size	A	L	M	T
1/2"	60	65,5	112	24
3/4"	70	76,2	138	30
1"	70	83,3	138	33,5
1 1/4"	88	91,3	160	41,5
1 1/2"	94	103,3	205	51,5
2"	100	116,5	205	63
2 1/2"	150	147,3	330	83,5
3"	165	169	330	100
4"	175	198	340	118,5

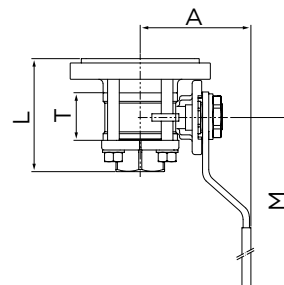



Ref. 2053



**Válvula esfera paso total fondo de cubas**  
 Const. acero inox. CF8M (316) y 316l (fondo de cubas).  
**Extremo butt weld ANSI B 16.25 y fondo de cubas.**  
 Asientos PTFE + 15% FV. Tórica eje vitón.  
 PN 63. Temp. -25°C +180°C. Montaje directo s/ISO 5211.  
 Mando manual por palanca con sistema de bloqueo.

**Tank bottom full bore ball valve**  
 Const. stainless steel CF8M (316) and 316l (tank bottom).  
**Ends: butt weld ANSI B 16.25 and tank bottom.**  
 Seats: PTFE + 15% FV. O'ring stem: viton.  
 PN 63. Temp. -25°C +180°C. Direct assembling ISO 5211.  
 Manually operated by handle with locking system.

Medida/Size	A	L	M	T
1/2"	60	65,5	112	24
3/4"	70	76,2	138	30
1"	70	83,3	138	33,5
1 1/4"	88	91,3	160	41,5
1 1/2"	94	103,3	205	51,5
2"	100	116,5	205	63
2 1/2"	150	147,3	330	83,5
3"	165	169	330	100
4"	175	203	340	118,5

CÓDIGO CODE	MEDIDA SIZE	PESO WEIGHT	P.V.P. € PRICE €
2053 04	1/2"	0,440	-
2053 05	3/4"	0,820	-
2053 06	1"	1,020	-
2053 07	1 1/4"	1,790	-
2053 08	1 1/2"	2,460	-
2053 09	2"	3,470	-
2053 10	2 1/2"	8,500	-
2053 11	3"	12,400	-
2053 12	4"	16,650	-

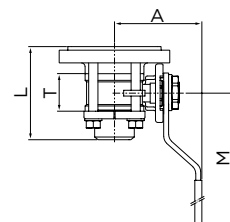

Ref. 2035



**Válvula esfera paso reducido 1 pieza**  
 Const. cuerpo: acero carbono DIN ST-37.  
 Extremos prolongados para soldar.  
 Esfera INOX. 304. Eje INOX. 303. Asientos PTFE + grafito.  
 Tóricas eje viton. PN 25/40. Temp. -30°C +200°C.  
 Mando manual por palanca hasta 6". Reductor manual >6".

**1 pc reduce bore ball valve. District heating**  
 Const. carbon steel DIN ST-37. Extended butt weld ends.  
 Ball: SS 304. stem: ss 303. Seats: PTFE + graphite.  
 O'rings stem: viton. PN 25/40. Temp. -30°C +200°C.  
 Manually operated by handle, until 6". Gear operator >6".

DN	PN	D	D1	D2	S	H	H1	A	L
15	40	10	21,3	38	2,5	100	40	120	230
20	40	15	26,9	42	3	100	40	120	230
25	40	20	33,7	51	3	105	40	150	230
32	40	25	42,4	57	3	105	40	150	260
40	40	32	48,3	76,1	3	125	59	190	260
50	40	40	60,3	88,9	3	130	59	190	300
65	25	50	76,1	108	3	180	71	280	300
80	25	65	88,9	127	4	190	77	280	325
100	25	80	114,3	153	4	190	77	280	300
125	25	100	139,7	177,8	4,5	245	95	420	325
150	25	125	168,3	219,1	6	265	103	550	350
200	25	150	219,1	273	6	-	-	-	400
250	25	200	273	355,6	7	-	-	-	530
300	25	250	323,9	457	8	-	-	-	550

2035 04	1/2"	1,000	-
2035 05	3/4"	1,200	-
2035 06	1"	1,400	-
2035 07	1 1/4"	1,800	-
2035 08	1 1/2"	2,600	-
2035 09	2"	3,600	-
2035 10	2 1/2"	5,200	-
2035 11	3"	6,600	-
2035 12	4"	9,900	-
2035 13	5"	14,500	-
2035 14	6"	24,300	-
2035 16	8"	56,000	-
2035 18	10"	87,500	-
2035 20	12"	130,000	-

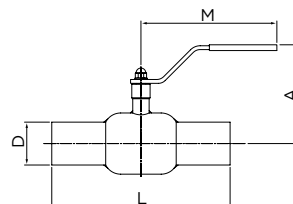

Ref. 2102 - D2102



**Válvula de compuerta con cierre de EPDM y cuerpo de fundición nodular PN 16**  
 Vástago fijo. Diseño según DIN 3352, DIN 2501, DIN 3202-F4 apta para conducción de agua. Temp. máx. de trabajo 80°C.

**Gate valve with EPDM seal and ductile iron body PN 16**  
 Fixed stem. Design according to DIN 3352, DIN 2501, DIN 3202-F4. Suitable for water conduction. Max. working temp. 80°C.

**Adaptador opcional**  
**Optional adapter**

DN	A	B	C	D
50	150	240	180	165
65	170	270	180	185
80	180	300	200	200
100	190	330	250	220
125	200	375	280	250
150	210	425	280	285
200	230	515	320	340
250	250	600	350	405
300	270	685	400	460

2102 09	2"	9,400	-
2102 10	2 1/2"	12,250	-
2102 11	3"	14,000	-
2102 12	4"	17,600	-
2102 13	5"	25,000	-
2102 14	6"	33,000	-
2102 16	8"	53,600	-
2102 18	10"	82,900	-
2102 20	12"	119,500	-
D2102 09	2" - 4"	0,580	-
D2102 13	5"-6"	0,250	-
D2102 16	8"	0,492	-
D2102 18	10"-12"	0,672	-

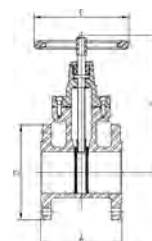

# LÍNEA INDUSTRIAL / INDUSTRIAL LINE

01 VÁLVULAS INDUSTRIALES INDUSTRIAL VALVES

Ref. 2104 - 5104



**Válvula mariposa tipo wafer**  
**Montaje entre bridas PN 10/16 - ANSI 150 lbs**

Cuerpo, eje y disco: inoxidable 316 (CF8M).  
 Asiento: PTFE con base de EPDM. Temp. -25°C +180°C.  
 Mando manual por palanca de inoxidable hasta 5", mayor de 5" con reductor. Longitud entre caras según DIN 3202K1. Presión de trabajo: 10 bar

**Wafer type butterfly valve**  
**Mounting between flanges PN 10/16 - ANSI 150 lbs**

Body, stem and disc: stainless steel 316 (CF8M).  
 Seat: PTFE with EPDM backup ring. Temp. -25°C +180°C.  
 Manually operated by stainless steel handle until 5", from 6" with gear operator. Face to face according to DIN 3202 K1. Working pressure: 10 bar

**Art. 5104 de 2" a 5" con reductor manual.**

**Art. 5104 from 2" to 5" with gear operator.**

Medida/Size	L	A1	A2	D	P
2"	43	168	74	65	270
2 1/2"	46	170	82	65	270
3"	46	170	90	65	270
4"	52	190	116	90	270
5"	56	206	132	90	270
6"	56	222	145	90	-
8"	60	274	180	125	-
10"	68	310	210	125	-

CÓDIGO CODE	MEDIDA SIZE	PESO WEIGHT	P.V.P. € PRICE €
-------------	-------------	-------------	------------------

2104 09	2"	2,700	-
2104 10	2 1/2"	3,300	-
2104 11	3"	3,640	-
2104 12	4"	5,700	-
2104 13	5"	7,400	-
2104 14	6"	10,516	-
2104 16	8"	18,916	-
2104 18	10"	24,900	-

5104 09	2"	4,200	-
5104 10	2 1/2"	4,800	-
5104 11	3"	6,350	-
5104 12	4"	7,950	-
5104 13	5"	9,650	-

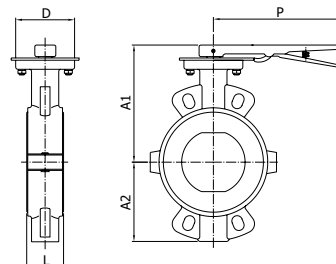

Ref. 2101 - 5101



**Válvula mariposa tipo wafer**  
**Montaje entre bridas PN 10/16 - ANSI 150 lbs**

Cuerpo fundición nodular GGG-40. Eje y disco: Inox. 316.  
 Asiento: PTFE con base de silicona. Temp. -25°C +180°C.  
 Mando manual por palanca de fundición. Longitud entre caras según DIN 3202K1. Presión de trabajo: 10 bar

**Wafer type butterfly valve**  
**Mounting between flanges PN 10/16 - ANSI 150 lbs**

Body, ductile iron GGG-40. Stem and disc: stainless steel 316.  
 Seat: PTFE with silicone backup ring. Temp. -25°C +180°C.  
 Manually operated by handle until 5", from 6" with cast iron gear operator. Face to face according to DIN 3202 K1. Working pressure: 10 bar

**Art. 5101 de 2" a 5" con reductor manual.**

**Art. 5101 from 2" to 5" with gear operator.**

Medida/Size	L	A1	A2	D	P
2"	43	136	75	70	172
2 1/2"	46	145	80	70	172
3"	46	153	85	70	172
4"	52	170	114	90	218
5"	56	185	127	90	218
6"	56	200	140	90	***
8"	60	231	175	125	-

2101 09	2"	2,650	-
2101 10	2 1/2"	3,180	-
2101 11	3"	3,750	-
2101 12	4"	5,850	-
2101 13	5"	7,500	-
2101 14	6"	13,000	-
2101 16	8"	17,400	-

5101 09	2"	4,420	-
5101 10	2 1/2"	4,680	-
5101 11	3"	5,040	-
5101 12	4"	7,030	-
5101 13	5"	8,370	-

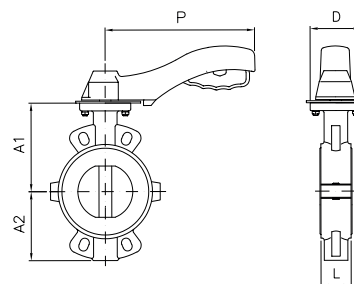

**Ref. 2108 - 5108**



**Válvula mariposa tipo Lug**  
**Montaje entre bridas PN 10/16**  
 PN 16 ≤ DN 150 - PN 10 ≥ DN 200.  
 Cuerpo fundición nodular GGG-40. Disco CF8M (316).  
 Elastómero EPDM. Tóricas eje NBR.  
 Temperatura de trabajo -20°C +120°C.  
 Montaje actuador s / ISO 5211. Palanca hasta 10".  
 Reductor manual a partir de 12".

**Lug type butterfly valve**  
**Mounting between DIN PN 10/16 flanges**  
 PN 16 ≤ DN 150 - PN 10 ≥ DN 200.  
 Body: ductile iron GGG-40. Disc: CF8M (316).  
 Seat: EPDM. Stem o'ring NBR.  
 Working temperature -20°C +120°C.  
 Mounting actuator according to ISO 5211 std.  
 Handle up to 10" with gear operator from 12".

**Art. 5108 de 2" a 10" con reductor manual.**

**Art. 5108 from 2" to 10" with gear operator.**

Medida/Size	L	A1	A2	D	P
2"	43	240	79	90	216
2 1/2"	46	240	93	90	216
3"	46	245	103	90	216
4"	52	265	120	90	216
5"	56	290	133	90	216
6"	56	240	158	125	300
8"	60	280	180	125	300
10"	68	325	216	125	300
12"	78	351	251	150	-

CÓDIGO CODE	MEDIDA SIZE	PESO WEIGHT	P.V.P. € PRICE €
2108 09	2"	4,160	-
2108 10	2 1/2"	4,407	-
2108 11	3"	5,612	-
2108 12	4"	7,673	-
2108 13	5"	9,330	-
2108 14	6"	12,678	-
2108 16	8"	16,433	-
2108 18	10"	28,733	-
2108 20	12"	51,367	-

5108 09	2"	7,400	-
5108 10	2 1/2"	7,800	-
5108 11	3"	9,000	-
5108 12	4"	11,400	-
5108 13	5"	13,000	-
5108 14	6"	16,780	-
5108 16	8"	25,560	-
5108 18	10"	37,830	-

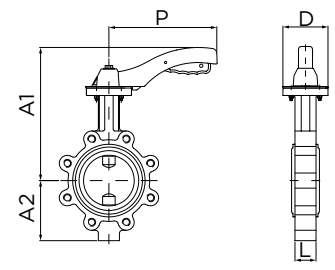

**Ref. 2108A - 5108A**



**Válvula mariposa tipo Lug**  
**Montaje entre bridas ANSI 125/150**  
 Cuerpo fundición nodular GGG-40. Disco CF8M (316).  
 Elastómero EPDM. Tóricas eje NBR.  
 Temperatura de trabajo -20°C +120°C.  
 Montaje actuador s/ISO 5211. Palanca hasta 10".  
 Reductor manual a partir de 12".

**Lug type butterfly valve**  
**Mounting between ANSI class 125/150 flanges**  
 Body: ductile iron GGG-40. Disc: CF8M (316).  
 Seat: EPDM. Stem o'ring NBR.  
 Working temperature -20°C +120°C.  
 Mounting actuator according to ISO 5211 std.  
 Handle up to 10" with gear operator from 12".

**Art. 5108A de 2" a 10" con reductor manual.**

**Art. 5108A from 2" to 10" with gear operator.**

Medida/Size	L	A1	A2	D	P
2"	43	240	79	90	216
2 1/2"	46	240	93	90	216
3"	46	245	103	90	216
4"	52	265	120	90	216
5"	56	290	133	90	216
6"	56	240	158	125	300
8"	60	280	180	125	300
10"	68	325	216	125	300
12"	78	351	251	150	-
14"	78	346	262	150	-
16"	102	375	301	175	-
18"	114	400	333	175	-
20"	127	432	366	175	-

2108A 09	2"	4,200	-
2108A 10	2 1/2"	4,500	-
2108A 11	3"	4,874	-
2108A 12	4"	7,678	-
2108A 13	5"	9,100	-
2108A 14	6"	12,618	-
2108A 16	8"	17,129	-
2108A 18	10"	28,400	-
2108A 20	12"	50,383	-
2108A 22	14"	65,600	-
2108A 24	16"	91,066	-
2108A 26	18"	132,967	-
2108A 28	20"	184,600	-

5108A 09	2"	8,710	-
5108A 10	2 1/2"	9,114	-
5108A 11	3"	9,490	-
5108A 12	4"	12,290	-
5108A 13	5"	13,000	-
5108A 14	6"	16,730	-
5108A 16	8"	26,900	-
5108A 18	10"	37,200	-

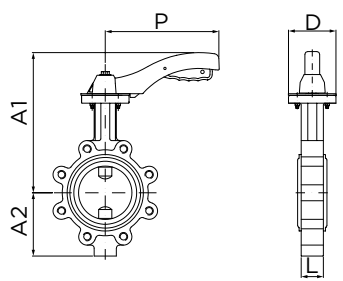

# LÍNEA INDUSTRIAL / INDUSTRIAL LINE

Ref. 2103 - 5103



**Válvula mariposa tipo wafer  
PN 10/16. ANSI 150 lbs**

Cuerpo hierro fundido.+epoxy.  
Disco fdon.nodular zincado. Elastómero EPDM.  
Toricas eje NBR. Temp. máx. 120°C.  
Brida montaje actuadores s/ISO 5211.  
Palanca hasta 10" reductor manual a partir de 12".

**Wafer type butterfly valve  
PN 10/16 ANSI 150 lbs**

Body: cast iron + epoxy. Disk: zinc plated. Elastomer: EPDM. O'ring stem: NBR.  
Max. temp. 120°C. Flanges mounted actuators ISO 5211 handle up to 10" with gear operator from 12".

**Art. 5103 de 2" a 10" con reductor manual.**

**Art. 5103 from 2" to 10" with gear operator.**

Medida/Size	L	A1	A2	D	P	PN
2"	43	238	70	65	170	16
2 1/2"	46	238	80	65	170	16
3"	46	238	100	65	170	16
4"	52	270	115	90	215	16
5"	56	300	135	90	215	16
6"	56	300	150	90	215	16
8"	60	280	180	125	300	16
10"	68	330	215	125	300	16
12"	78	360	250	150	-	16
14"	78	390	260	150	-	10
16"	102	420	300	175	-	10
18"	114	445	330	175	-	10
20"	127	480	370	175	-	10

CÓDIGO CODE	MEDIDA SIZE	PESO WEIGHT	P.V.P. € PRICE €
2103 09	2"	2,660	-
2103 10	2 1/2"	3,159	-
2103 11	3"	3,684	-
2103 12	4"	5,646	-
2103 13	5"	7,261	-
2103 14	6"	8,304	-
2103 16	8"	13,669	-
2103 18	10"	20,201	-
2103 20	12"	37,084	-
2103 22	14"	55,511	-
2103 24	16"	74,466	-
2103 26	18"	115,900	-
2103 28	20"	139,233	-
5103 09	2"	7,560	-
5103 10	2 1/2"	7,700	-
5103 11	3"	8,250	-
5103 12	4"	10,250	-
5103 13	5"	12,200	-
5103 14	6"	12,950	-
5103 16	8"	22,680	-
5103 18	10"	32,000	-

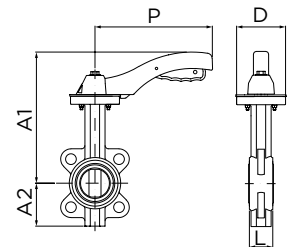

Ref. 2109 - 5109



**Válvula mariposa tipo wafer  
PN-10/16. ANSI 150 lbs**

Cuerpo hierro fundido + epoxy **disco acero inox. AISI 316.**  
Elastómero EPDM. Tóricas eje NBR. Temp. máx. 120°C.  
Brida montaje actuadores S/ISO 5211. Palanca hasta 10" reductor manual a partir de 12".

**Wafer type butterfly valve  
PN 10/16. ANSI 150 lbs**

Body: cast iron + epoxy. Disk: stainless steel AISI 316.  
Elastomer: EPDM. O'ring stem: NBR. Max. temp. 120°C.  
Flanges mounted actuators ISO 5211.  
Handle up to 10" with gear operator from 12".

**Art. 5109 de 2" a 10" con reductor manual.**

**Art. 5109 from 2" to 10" with gear operator.**

Medida/Size	L	A1	A2	D	P	PN
2"	43	238	70	65	170	16
2 1/2"	46	238	80	65	170	16
3"	46	238	100	65	170	16
4"	52	270	115	90	215	16
5"	56	300	135	90	215	16
6"	56	300	150	90	215	16
8"	60	280	180	125	300	16
10"	68	330	215	125	300	16
12"	78	360	250	150	-	16
14"	78	390	260	150	-	10
16"	102	420	300	175	-	10
18"	114	445	330	175	-	10
20"	127	480	370	175	-	10

CÓDIGO CODE	MEDIDA SIZE	PESO WEIGHT	P.V.P. € PRICE €
2109 09	2"	2,607	-
2109 10	2 1/2"	3,150	-
2109 11	3"	3,560	-
2109 12	4"	5,400	-
2109 13	5"	6,806	-
2109 14	6"	7,856	-
2109 16	8"	14,170	-
2109 18	10"	21,563	-
2109 20	12"	38,706	-
2109 22	14"	55,471	-
2109 24	16"	73,813	-
2109 26	18"	118,800	-
2109 28	20"	140,125	-

Válvula con elastómero NBR (2109B) y FPM (2109V). Precios a consultar. / NBR elastomer valve (2109B) and FPM elastomer (2109V). Prices on request.

CÓDIGO CODE	MEDIDA SIZE	PESO WEIGHT	P.V.P. € PRICE €
5109 09	2"	5,800	-
5109 10	2 1/2"	6,300	-
5109 11	3"	6,800	-
5109 12	4"	9,000	-
5109 13	5"	10,400	-
5109 14	6"	12,500	-
5109 16	8"	17,400	-
5109 18	10"	24,200	-

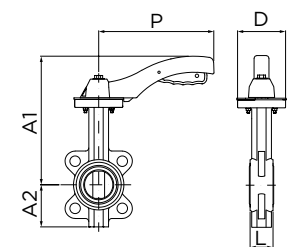

Ref. 2113



**Válvula mariposa tipo wafer con reductor manual y microrruptor final de carrera. PN 10/16. ANSI 150 lbs**

Cuerpo fundición nodular GGG.40.  
Disco fundición nodular + EPDM.  
Diseño según API 609. Distancia entre caras según ASME B16.10.  
Presión de trabajo 300 PSI. Temp. de trabajo: 0°C +80°C.  
**Certificación UL/FM.**

**Wafer type butterfly valve with gear-box and limit switch. PN 10/16. ANSI 150 lbs**

Body made of ductile iron GGG.40. Disc: D.I + EPDM.  
Design according to API 609.  
Face to face according to ASME B16.10.  
Working pressure 300 PSI. Working temperature: 0°C +80°C.  
**UL/FM certification.**

Medida/Size	L	A	B	H	K	J
2 1/2"	44,2	125	95	111	153	152
3"	45,3	140	100	111	153	152
4"	52	160	100	111	153	152
5"	54,4	170	125	111	153	152
6"	55,8	190	140	111	153	200
8"	60,5	230	175	126	210	300

CÓDIGO CODE	MEDIDA SIZE	PESO WEIGHT	P.V.P. € PRICE €
2113 10	2 1/2"	8,700	-
2113 11	3"	9,000	-
2113 12	4"	11,850	-
2113 13	5"	12,000	-
2113 14	6"	14,600	-
2113 16	8"	26,500	-

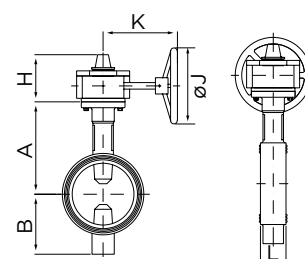

Ref. 2114 - 2114D



**Válvula mariposa - Extremos ranurados con reductor manual y microrruptor final de carrera**

Cuerpo fundición nodular GGG.40.  
Disco fundición nodular + EPDM.  
Diseño según API 609. Ranurado según AWWA C606.  
Distancia entre caras según MSS SP-67.  
Presión de trabajo 300 PSI. Temp. de trabajo: 0°C +80°C.  
**Certificación UL/FM.**

**Grooved ends Butterfly valve with gear-box and limit switch**

Body made of ductile iron GGG.40. Disc: D.I + EPDM.  
Design according to API 609. Grooved standard AWWA C606.  
Face to face according to MSS SP-67.  
Working pressure 300 PSI. Working temperature: 0°C +80°C.  
**UL/FM certification.**

Medida/Size	L	D	E	F	G	A	B	H	K	J
2 1/2"	96,8	73	69,1	15,9	7,9	125	95	111	153	152
3"	96,8	88,9	84,9	15,9	7,9	140	100	111	153	152
4"	115,8	114,3	110,1	15,9	9,5	160	100	111	153	152
5"	147,6	141,3	137	15,9	9,5	170	125	111	153	152
6"	147,6	168,3	164	15,9	9,5	190	140	111	153	200
8"	133,4	219,1	214,4	19	11,1	230	175	126	210	300
DN 65	96,8	76,1	72,3	15,9	7,9	125	95	111	153	152
DN 125	147,6	139,7	135,5	15,9	9,5	170	125	111	153	152
DN 150	147,6	165,1	160,9	15,9	9,5	190	140	111	153	200

2114 10	2 1/2"	8,300	-
2114 11	3"	8,800	-
2114 12	4"	9,860	-
2114 13	5"	12,900	-
2114 14	6"	14,900	-
2114 16	8"	28,200	-
2114D 10	DN 65	8,400	-
2114D 13	DN 125	13,800	-
2114D 14	DN 150	14,700	-

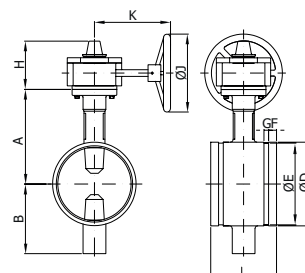

Ref. 2120 - 2120D



**Válvula mariposa - Extremos ranurados**

Con palanca hasta 8" y con reductor manual a partir de 10".  
Cuerpo fundición nodular GGG.40.  
Disco fundición nodular + EPDM.  
Diseño según API 609. Ranurado según AWWA C606.  
Distancia entre caras según MSS SP-67.  
Presión de trabajo 300 PSI. Temp. de trabajo: 0°C +80°C.

**Grooved ends butterfly valve with handle**

With handle up to 8" and with gear operator from 10".  
Body made of ductile iron GGG.40. Disc: D.I + EPDM.  
Design according to API 609. Grooved standard AWWA C606.  
Face to face according to MSS SP-67.  
Working pressure 300 PSI. Working temperature: 0°C +80°C.

Medida/Size	L	D	E	F	G	A	B	H	K
2"	81	60,3	57,2	15,9	7,9	110	85	32	267
2 1/2"	96,8	73	69,1	15,9	7,9	125	95	32	267
3"	96,8	88,9	84,9	15,9	7,9	140	100	32	267
4"	115,8	114,3	110,1	15,9	9,5	160	100	32	267
5"	147,6	141,3	137	15,9	9,5	170	125	32	267
6"	147,6	168,3	164	15,9	9,5	190	140	32	267
8"	133,4	219,1	214,4	19	11,1	200	175	37	353
10"	158,8	273	268,3	19	12,7	260	200	77	---
12"	165,1	323,8	318,3	19	12,7	300	240	77	---
DN 65	96,8	73	69,1	15,9	7,9	125	95	32	267
DN 125	147,6	141,3	137	15,9	9,5	170	125	32	267
DN 150	147,6	168,3	164	15,9	9,5	190	140	32	267

2120 09	2"	2,500	-
2120 10	2 1/2"	3,000	-
2120 11	3"	3,500	-
2120 12	4"	4,800	-
2120 13	5"	7,600	-
2120 14	6"	9,500	-
2120 16	8"	17,300	-
2120 18	10"	35,400	-
2120 20	12"	49,600	-

2120D 10	DN 65	3,100	-
2120D 13	DN 125	9,500	-
2120D 14	DN 150	10,400	-

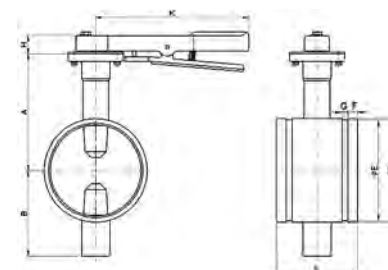

# LÍNEA INDUSTRIAL / INDUSTRIAL LINE

01 VÁLVULAS INDUSTRIALES INDUSTRIAL VALVES

Ref. 2094



### Válvula de compuerta cierre de EPDM - Extremos Bridados.

Válvula de compuerta cierre de EPDM - Extremos Bridados.  
Const. Cuerpo y bonete de fundición nodular GGG.40.  
Diseño según AWWA C515. Bridas ASME B16.42.  
Distancia entre caras según ASME B16.10. Husillo ascendente.  
Presión de trabajo 300 PSI. Temp. de trabajo: 0°C +80°C.

**Certificación UL/FM.**

### Gate valve with EPDM seat - Flanged ends.

Gate valve with EPDM seat - Flanged ends.  
Body and bonnet made of ductile iron GGG.40.  
Design according to AWWA C515. Flanged ends standard ASME B16.42.  
Face to face according to ASME B16.10. Rising stem (OS&Y).  
Working pressure 300 PSI. Working temperature: 0°C +80°C.

**UL/FM certification.**

Medida/Size	L	D	H	V
2 1/2"	190	178	370	190
3"	203	191	420	256
4"	229	229	447	256
5"	254	254	547	310
6"	267	279	607	310
8"	292	343	754	355
10"	330	406	890	446
12"	356	483	1031	446

CÓDIGO CODE	MEDIDA SIZE	PESO WEIGHT	P.V.P. € PRICE €
2094 10	2 1/2"	21,700	-
2094 11	3"	27,900	-
2094 12	4"	35,100	-
2094 13	5"	49,100	-
2094 14	6"	59,700	-
2094 16	8"	95,900	-
2094 18	10"	141,800	-
2094 20	12"	191,000	-

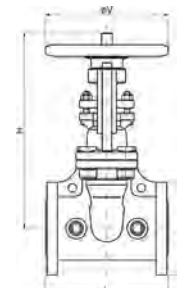

Ref. 2100 - 2100D



### Válvula de compuerta cierre de EPDM - Extremos ranurados

Const. Cuerpo y bonete de fundición nodular GGG.40.  
Diseño según AWWA C515. Ranurado según AWWA C606.  
Distancia entre caras según ASME B16.10. Husillo ascendente.  
Presión de trabajo 300 PSI. Temp. de trabajo: 0°C +80°C.

**Certificación UL/FM.**

### Gate valve with EPDM seat - Groove ends

Body and bonnet made of ductile iron GGG.40.  
Design according to AWWA C515. Grooved standard AWWA C606.  
Face to face according to ASME B16.10. Rising stem (OS&Y).  
Working pressure 300 PSI. Working temperature: 0°C +80°C.

**UL/FM certification.**

Medida/Size	L	D	E	F	G	H	V
2 1/2"	190	73	69,1	15,9	7,9	370	190
3"	203	88,9	84,9	15,9	7,9	420	256
4"	229	114,3	110,1	15,9	9,5	447	256
5"	254	141,3	137	15,9	9,5	547	310
6"	267	168,3	164	15,9	9,5	607	310
8"	292	219,1	214,4	19	11,1	754	355
10"	330	273	268,3	19	12,7	890	446
12"	356	323,9	318,3	19	12,7	1031	446
DN 65	190	76,1	72,3	15,9	7,9	370	190
DN 125	254	139,7	135,5	15,9	9,5	547	310
DN 150	267	165,1	160,9	15,9	9,5	607	310

2100 10	2 1/2"	15,800	-
2100 11	3"	20,800	-
2100 12	4"	25,200	-
2100 13	5"	38,600	-
2100 14	6"	46,600	-
2100 16	8"	73,100	-
2100 18	10"	108,500	-
2100 20	12"	150,000	-
2100D 10	DN 65	16,700	-
2100D 13	DN 125	40,000	-
2100D 14	DN 150	47,600	-

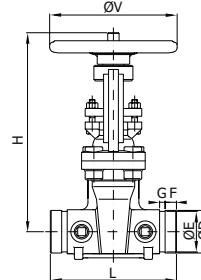

Ref. 2403



### Válvula de retención disco oscilante - Extremos Bridados.

Construcción cuerpo y tapa de fundición nodular GGG.40. Asiento EPDM.  
Diseño según AWWA C508. Bridas ASME B16.42.  
Distancia entre caras según ASME B16.10.  
Presión de trabajo 300 PSI. Temp. de trabajo: 0°C +80°C.

**Certificación UL/FM.**

### Flanged end Swing Check Valve

Body and cap made of ductile iron GGG.40. EPDM seat.  
Design according to AWWA C508. Flanged ends standard ASME B16.42.  
Face to face according to ASME B16.10.  
Working pressure 300 PSI. Working temperature: 0°C +80°C.

**UL/FM certification.**

Medida/Size	L	D	H
2"	203	152	142
2 1/2"	216	178	148
3"	241	191	163
4"	292	229	172
5"	330	254	237
6"	356	279	243
8"	495	343	301
10"	622	406	348
12"	698	483	419

2403 09	2"	14,500	-
2403 10	2 1/2"	18,520	-
2403 11	3"	23,760	-
2403 12	4"	31,950	-
2403 13	5"	52,000	-
2403 14	6"	64,000	-
2403 16	8"	119,600	-
2403 18	10"	182,000	-
2403 20	12"	280,000	-

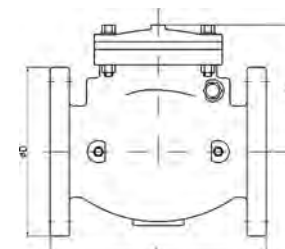

Ref. 2105



**Tipo Wafer. Válvula esfera paso total 1 pieza montaje entre bridas PN 16**

Cuerpo acero carbono A-105 bola eje y tapa: inox. AISI 304.  
Asientos y juntas: PTFE. Temp. -20°C +180°C.  
Mando manual por palanca.

**Wafer type. 1 pc full bore ball valve mounting between flanges PN 16**

Body: carbon steel A-105. Ball, stem and cover: stainless steel AISI 304.  
Seats and seals: PTFE. Temp. -20°C +180°C.  
Manually operated by handle.

DN	D	A	L	M
25	110	90	45	180
32	130	110	54	270
40	140	110	65	280
50	150	125	72	280
65	170	150	98	360
80	190	160	118	360
100	220	180	140	470

CÓDIGO CODE	MEDIDA SIZE	PESO WEIGHT	P.V.P. € PRICE €
2105 06	1"	3,000	-
2105 07	1 1/4"	5,000	-
2105 08	1 1/2"	6,500	-
2105 09	2"	8,000	-
2105 10	2 1/2"	16,000	-
2105 11	3"	21,000	-
2105 12	4"	30,000	-

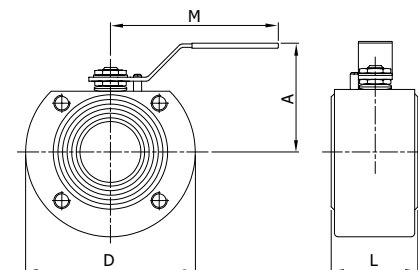

Ref. 2110



**Tipo Wafer. Válvula esfera paso total 1 pieza montaje entre bridas PN 16**

Cuerpo bola y eje: inox. AISI 316.  
Asientos y juntas: PTFE Temp. -20°C +180°C.  
Mando manual por palanca.

**Wafer type. 1 pc full bore ball valve mounting between flanges PN 16**

Body ball and stem: stainless steel AISI 316.  
Seats and seals: PTFE Temp. -20°C +180°C.  
Manually operated by handle.

DN	D	A	L	M
15	90	90	32	130
20	100	90	42	180
25	110	90	45	180
32	130	110	54	270
40	140	110	65	280
50	150	125	72	280
65	170	150	98	360
80	190	160	118	360
100	220	180	140	470

2110 04	1/2"	1,500	-
2110 05	3/4"	2,000	-
2110 06	1"	3,000	-
2110 07	1 1/4"	5,000	-
2110 08	1 1/2"	6,500	-
2110 09	2"	8,000	-
2110 10	2 1/2"	16,000	-
2110 11	3"	21,000	-
2110 12	4"	30,000	-

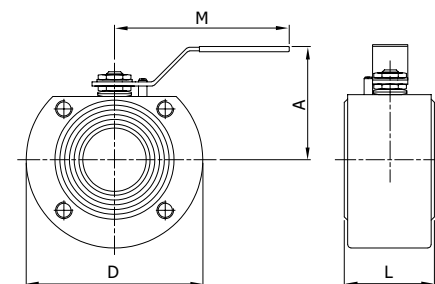

Ref. 2115



**Tipo wafer. Válvula esfera paso total 1 pieza con cámara de calefacción montaje entre bridas PN 16**

Cuerpo: acero al carbono forjado A-105. bola, eje y tapa: inox. AISI 304  
asientos y juntas: PTFE. Temp. -20°C +180°C. Mando manual por palanca.

**Wafer type. 1 pc full bore ball valve with heating chamber mounting between flanges PN 16**

Body: forged carbon steel A-105. Ball stem and cover: stainless steel AISI 304.  
Seats and seals: PTFE Temp. -20°C +180°C. Manually operated by handle.

DN	L	d
25	170	3/4"
32	190	3/4"
40	200	3/4"
50	210	3/4"
65	235	3/4"
80	250	3/4"
100	270	3/4"

2115 06	1"	4,200	-
2115 07	1 1/4"	5,500	-
2115 08	1 1/2"	6,800	-
2115 09	2"	8,500	-
2115 10	2 1/2"	16,500	-
2115 11	3"	21,500	-
2115 12	4"	31,000	-

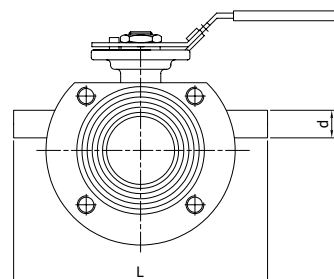

# LÍNEA INDUSTRIAL / INDUSTRIAL LINE

01 VÁLVULAS INDUSTRIALES INDUSTRIAL VALVES

Ref. 2118



**Tipo Wafer. Válvula esfera paso total 1 pieza montaje entre bridas PN 16**

Const. acero inox CF8M (316) microfusión. Esfera y eje inoxidable 316. Asientos PTFE + 15% FV. PN 16. Temp. -25°C +180°C. Montaje directo S/ISO 5211. Mando manual por palanca con sistema de bloqueo.

**Wafer type. 1 pc full bore ball valve mounting between flanges PN 16**

Const. stainless steel CF8M (316) investment casting. Ball and stem: stainless steel 316. Seats: PTFE + 15% GF. PN 16. Temp. -25°C +180°C. Direct assembling ISO 5211. Manually operated by handle with locking system.

Medida/Size	DN	L	M	D	H	n x d
1/2"	15	36	120	95	89	4 x M12
3/4"	20	38	120	105	94	4 x M12
1"	25	50	160	115	90	4 x M12
1 1/4"	32	53	160	140	100	4 x M16
1 1/2"	40	65	200	150	105	4 x M16
2"	50	78	200	165	125	4 x M16
2 1/2"	65	98	255	185	140	4 x M16
3"	80	118	255	200	145	8 x M16
4"	100	140	300	220	175	8 x M16

CÓDIGO CODE	MEDIDA SIZE	PESO WEIGHT	P.V.P. € PRICE €
2118 04	1/2"	1,235	-
2118 05	3/4"	1,570	-
2118 06	1"	1,920	-
2118 07	1 1/4"	3,550	-
2118 08	1 1/2"	4,560	-
2118 09	2"	6,190	-
2118 10	2 1/2"	9,491	-
2118 11	3"	13,812	-
2118 12	4"	19,080	-

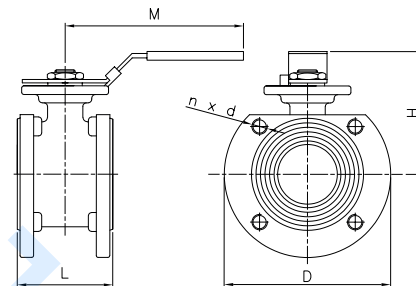

Ref. 2119



**Válvula esfera Paso Total 1 pieza con cámara de calefacción. Montaje entre bridas PN 16**

Const. acero inox CF8M (316) Microfusión. Esfera y eje inoxidable 316. Asientos PTFE + 15% FV. PN 16. Temp. -25 °C +180 °C. Montaje directo s/ ISO 5211. Mando manual por palanca con sistema de bloqueo.

**Wafer type - 1 Pc full bore ball valve with heating chamber. Mounting between flanges PN 16**

Const. stainless steel CF8M (316) investment casting. Ball and stem: stainless steel 316. Seats: PTFE + 15% GF. PN 16. Temp. -25 °C +180 °C. Direct assembling ISO 5211. Manually operated by handle with locking system.

Medida/Size	DN	L	d
1/2"	15	150	Rp 3/4"
3/4"	20	160	Rp 3/4"
1"	25	170	Rp 3/4"
1 1/4"	32	190	Rp 3/4"
1 1/2"	40	200	Rp 3/4"
2"	50	210	Rp 3/4"
2 1/2"	65	235	Rp 3/4"
3"	80	250	Rp 3/4"
4"	100	270	Rp 3/4"

2119 04	1/2"	1,500	-
2119 05	3/4"	1,900	-
2119 06	1"	2,600	-
2119 07	1 1/4"	3,850	-
2119 08	1 1/2"	4,950	-
2119 09	2"	6,650	-
2119 10	2 1/2"	10,300	-
2119 11	3"	14,450	-
2119 12	4"	20,250	-

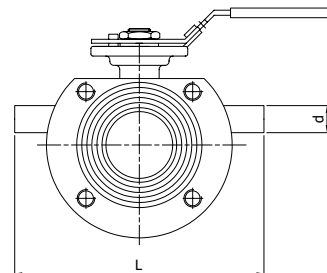

Ref. 2220 - 2220N



**Válvula de compuerta PN-16**

Rosca gas, también disponible con rosca NPT (2220N). Construcción: inox. CF8M (316) microfusión. Juntas: PTFE. Conexión: rosca gas ISO 7-1 (EN 10226-1). Presión máx.: 16BAR a 120°C - 10 BAR a 180°C. Temp. mín. -30°C.

**Gate valve PN-16**

Gas thread, also available NPT thread (2220N). Constr. stainless steel CF8M (316) investment casting. Gasket: PTFE; gas threaded ends ISO 7-1 (EN 10226-1). Max. pressure: 16 BAR at 120°C - 10 BAR at 180°C. Minimum temp.: -30°C.

R	DN	A	L	V
1/2"	15	100	55	70
3/4"	20	110	61	70
1"	25	115	68	70
1 1/4"	32	130	77	80
1 1/2"	40	150	80	100
2"	50	167	93	100

2220 04	1/2"	0,414	-
2220 05	3/4"	0,545	-
2220 06	1"	0,704	-
2220 07	1 1/4"	1,090	-
2220 08	1 1/2"	1,531	-
2220 09	2"	2,192	-

Precios rosca NPT a consultar / NPT thread prices on request

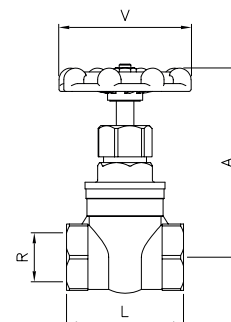



Ref. 2221 - 2222



**Válvulas de aguja - 3000 Lbs**  
**Art. 2221. Rosca gas ISO 228-1 H/H. Art. 2222. Rosca NPT H/H**

Construcción: acero A105 / aguja INOX A182 F316 + T. Térmico. Estopada: PTFE Presión máxima de trabajo 210 bar. Temperatura de trabajo -20°C a 250°C.

**Needle valve - 3000 Lbs**  
**Art. 2221. Gas thread ISO 228-1 F/F. Art. 2222. NPT thread F/F**

Constr. steel A105, needle stainless steel A182 F316 + Heat Treatment. Stem packing: PTFE Max. working pressure 210 bar. Working temperature -20°C to 250°C.

Medida/Size	E	H	L	K
1/4"	25	85	50	3
3/8"	30	100	55	4
1/2"	34	115	60	6
3/4"	40	120	70	8
1"	45	138	75	9

CÓDIGO CODE	MEDIDA SIZE	PESO WEIGHT	P.V.P. € PRICE €
2221 02	1/4"	0,342	-
2221 03	3/8"	0,401	-
2221 04	1/2"	0,530	-
2221 05	3/4"	0,800	-
2221 06	1"	1,011	-

Precios rosca NPT a consultar / NPT thread prices on request

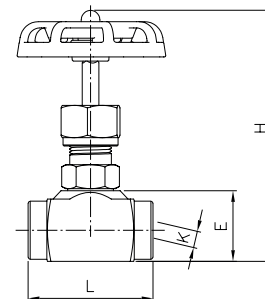

Ref. 2223 - 2224



**Válvulas de aguja - 3000 Lbs**  
**Art. 2223. Rosca gas ISO 228-1 H/H. Art. 2224. Rosca NPT H/H**

Construcción: acero inoxidable A182 F316/aguja inox A182 F316 + T. térmico. Estopada: PTFE. Presión máxima de trabajo 210 bar. Temperatura de trabajo: -20°C a 250°C.

**Needle valve - 3000 Lbs**  
**Art. 2223. Gas thread ISO 228-1 F/F. Art. 2224. NPT thread F/F**

Construction: stainless steel A182 F316/needle stainless steel A182 F316 + heat treatment. Stem packing PTFE. Max. working pressure 210 bar. Working temperature -20°C to 250°C.

Medida/Size	E	H	L	K
1/4"	25	85	50	3
3/8"	30	100	55	4
1/2"	34	115	60	6
3/4"	40	120	70	8
1"	45	138	75	9
1 1/4"	57	165	90	11
1 1/2"	67	185	100	15
2"	78	195	120	18

2223 02	1/4"	0,310	-
2223 03	3/8"	0,407	-
2223 04	1/2"	0,550	-
2223 05	3/4"	0,827	-
2223 06	1"	1,040	-
2223 07	1 1/4"	1,900	-
2223 08	1 1/2"	2,782	-
2223 09	2"	4,709	-

Precios rosca NPT a consultar / NPT thread prices on request

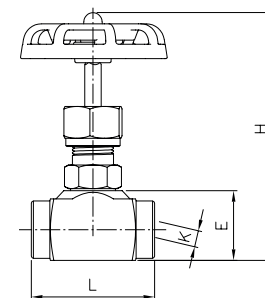

Ref. 2225 - 2225N



**Válvula de aguja - 6000 Lbs**

También disponible con rosca NPT (2225N).  
 Construcción: Acero inox. A182 F316 / Aguja inox A182 F316 + T. Térmico. Rosca ISO 228-1. Estopada PTFE. Presión máxima de trabajo 410 bar. Temperatura de trabajo -54°C a 250°C.

**Needle valve - 6000 Lbs**

Also available with NPT thread (2225N).  
 Construction: Stainless steel A182 F316 / Needle stainless steel A182 F316 + Heat treatment. Thread ISO 228-1. Stem packing PTFE. Max. working pressure 410 bar. Working temperature -54°C to 250°C.

Medida/Size	E	H	L	M	K
1/4"	25,5	90	61	55	4
3/8"	25,5	90	61	55	4
1/2"	28,5	92	68	55	5
3/4"	38	98	76	55	6
1"	44,5	108	85	55	8

2225 02	1/4"	0,380	-
2225 03	3/8"	0,360	-
2225 04	1/2"	0,440	-
2225 05	3/4"	0,800	-
2225 06	1"	1,031	-

Precios rosca NPT a consultar / NPT thread prices on request

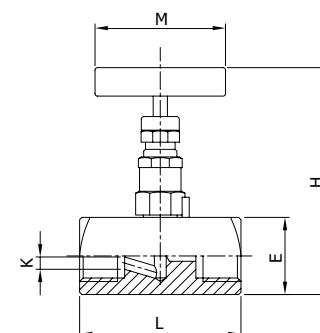

# LÍNEA INDUSTRIAL / INDUSTRIAL LINE

01 VÁLVULAS INDUSTRIALES INDUSTRIAL VALVES

Ref. 2226 - 2226N



### Válvula de aguja – 6000 lbs con purga

También disponible con rosca NPT (2226N).  
 Construcción: Acero inox. A182 F316 / Aguja inox A182 F316 + T. térmico.  
 Rosca ISO 228-1. Estopada PTFE. Presión máxima de trabajo 410 bar.  
 Temperatura de trabajo -54°C a 250°C.

### Needle valve – 6000 lbs with vent port

Also available with NPT thread (2226N).  
 Construction: Stainless steel A182 F316 / Needle stainless steel A182 F316 + Heat treatment. Thread ISO 228-1. Stem packing ptf. Max. working pressure 410 bar. Working temperature -54°C to 250°C.

Medida/Size	E	H	L	M	K
1/4"	28,5	90	75	55	4
1/2"	32	92	89	55	5

CÓDIGO CODE	MEDIDA SIZE	PESO WEIGHT	P.V.P. € PRICE €
-------------	-------------	-------------	------------------

2226 02	1/4"	0,550	-
2226 04	1/2"	0,600	-

Precios rosca NPT a consultar / NPT thread prices on request

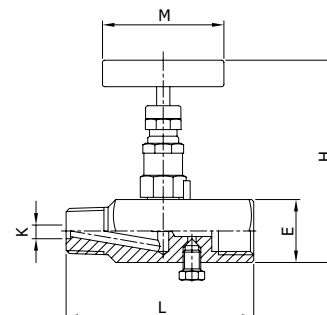

Ref. 8112N

### Manifolds para Instrumentación – Montaje a distancia

Construcción: Acero inox. 316. Rosca entrada/salida NPT.  
 Empaquetadura PTFE. Presión máxima de trabajo 410 bar.  
 Temperatura de trabajo -54°C a 250 °C.

### Instrument Manifolds – Remote operation

Construction: Stainless Steel 316. Input / Output NPT threaded.  
 Packing: PTFE. Max. working pressure 410 bar.  
 Working temperature -54°C to 250°C.



### 2 válvulas montaje a distancia

### 2 valves remote operation

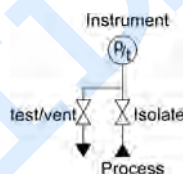

8112N 04 02	1/2"	0,750	-
-------------	------	-------	---



### 3 válvulas montaje a distancia

### 3 valves remote operation

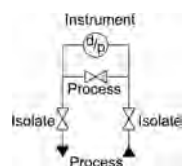

8112N 04 03	1/2"	1,480	-
-------------	------	-------	---



### 5 válvulas montaje a distancia

### 5 valves remote operation

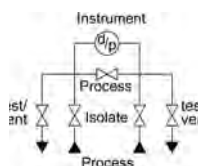

8112N 04 05	1/2"	2,950	-
-------------	------	-------	---

Ref. 8114N

### Manifolds para Instrumentación – Montaje directo; 2 válvulas montaje directo

### Instrument Manifolds – Direct mounting; 2 valves direct mounting



8114N 04 02	1/2"	0,780	-
-------------	------	-------	---

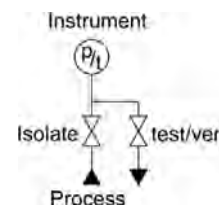

Ref. 2230 - 2230N



**Válvula de globo PN 16**

Rosca gas, también disponible en rosca NPT (2230N).  
 Construcción: inox. CF8M (316) microfusión.  
 Juntas: PTFE conexión: rosca gas ISO 7-1 (EN 10226-1).  
 Presión máx.: 16 BAR a 120°C 10 BAR a 180°C.

**Globe valve PN 16**

Gas thread, also available NPT thread (2230N).  
 Constr. stainless steel CF8M (316) investment casting.  
 Seals: PTFE: gas threaded ends ISO 7-1 (EN 10226-1).  
 Max. pressure: 16 BAR at 120°C - 10 BAR at 180°C.

R	DN	A	L	V
1/2"	15	97	65	70
3/4"	20	103	75	70
1"	25	116	90	70
1 1/4"	32	135	105	80
1 1/2"	40	152	120	100
2"	50	164	140	100

CÓDIGO CODE	MEDIDA SIZE	PESO WEIGHT	P.V.P. € PRICE €
2230 04	1/2"	0,450	-
2230 05	3/4"	0,650	-
2230 06	1"	0,845	-
2230 07	1 1/4"	1,169	-
2230 08	1 1/2"	1,880	-
2230 09	2"	2,496	-

Precios rosca NPT a consultar / NPT thread prices on request

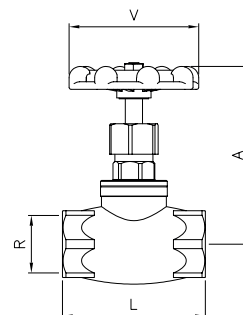

Ref. 2228



**Válvula de equilibrado estático - Bridas DIN PN 16**

Const. cuerpo y bonete fundición nodular GGG-40.  
 Eje acero inoxidable. Cierre en EPDM.  
 Orificio variable. Doble regulación.  
 Temperatura de trabajo -10°C +120°C.

**Static balancing valve - Flanged ends DIN PN 16**

Body and bonnet of ductil iron GGG-40.  
 Stainless steel stem. Sealing: EPDM.  
 Variable orifice. Double regulation.  
 Working temperature -10°C +120°C.

Medida/Size	DN	D	L	A	V
2"	50	165	230	276	180
2 1/2"	65	185	290	308	180
3"	80	200	310	320	180
4"	100	220	350	340	180
5"	125	250	400	375	180
6"	150	285	480	410	180
8"	200	340	600	550	350
10"	250	405	730	590	350
12"	300	460	850	678	450

2228 09	2"	11,400	-
2228 10	2 1/2"	16,375	-
2228 11	3"	19,580	-
2228 12	4"	25,928	-
2228 13	5"	41,000	-
2228 14	6"	54,316	-
2228 16	8"	103,000	-
2228 18	10"	151,500	-
2228 20	12"	221,000	-

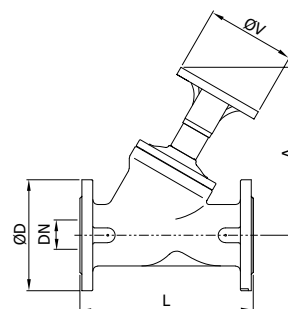

Ref. 3073



**Válvula de equilibrado estático**

PN 20. Construcción cuerpo y componentes internos en latón. Juntas VITON. Extremos rosca gas (BSP) H-H, ISO 228/1. Toma de presión G 1/8" H. Temperatura trabajo de -30°C a 120°C.

**Static balancing valve**

PN 20. Brass construction of body and inner components. Gas threaded ends (BSP) F-F, ISO 228/1. Pressure taps connection G 1/8" F. Working temperature from -30°C to 120°C.

R	A	B	C	D
1/2"	84	15	96	22
3/4"	85,6	17,8	97	21,5
1"	98	21,3	103,3	29,5
1 1/4"	101	28	111	29
1 1/2"	107	31	120	27
2"	115	37	132	21,9

3073 04	1/2"	0,480	-
3073 05	3/4"	0,477	-
3073 06	1"	0,680	-
3073 07	1 1/4"	0,930	-
3073 08	1 1/2"	1,180	-
3073 09	2"	1,547	-

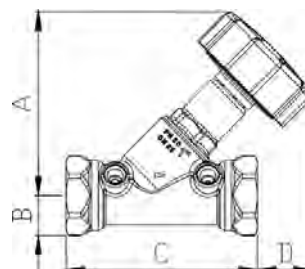

# LÍNEA INDUSTRIAL / INDUSTRIAL LINE

01 VÁLVULAS INDUSTRIALES INDUSTRIAL VALVES

Ref. 2231



### Válvula de globo con fuelle - Bridas DIN PN 16

Const. cuerpo y bonete acero al carbono GS-C25 (WCB).  
Material del fuelle: inoxidable 304. Junta y empaquetadura de grafito.  
Material de cierre: inoxidable. Temperatura máxima de trabajo 350°C.

### Bellow globe valve - Flanged ends DIN PN 16

Body and bonnet made of carbon steel GS-C25 (WCB).  
Bellow material: stainless steel 304. Gasket and packing: graphite.  
Seal material: stainless steel. Max. working temperature 350°C.

Medida/Size	DN	A	D	L	V
1/2"	15	195	95	130	140
3/4"	20	200	105	150	140
1"	25	220	115	160	160
1 1/4"	32	225	140	180	160
1 1/2"	40	235	150	200	180
2"	50	250	165	230	180
2 1/2"	65	260	185	290	220
3"	80	265	200	310	250
4"	100	370	220	350	300
5"	125	400	250	400	350
6"	150	515	285	480	400
8"	200	550	340	600	500

CÓDIGO CODE	MEDIDA SIZE	PESO WEIGHT	P.V.P. € PRICE €
2231 04	1/2"	4,200	-
2231 05	3/4"	5,000	-
2231 06	1"	5,800	-
2231 07	1 1/4"	7,200	-
2231 08	1 1/2"	9,200	-
2231 09	2"	11,300	-
2231 10	2 1/2"	15,400	-
2231 11	3"	20,500	-
2231 12	4"	37,200	-
2231 13	5"	55,400	-
2231 14	6"	80,600	-
2231 16	8"	129,400	-

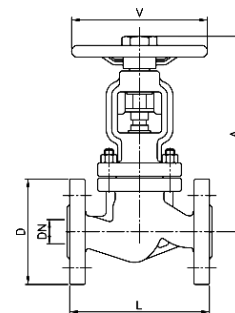

Ref. 2229A



### Válvula de compuerta con bridas ANSI clase 150

Const. Cuerpo y bonete acero al carbono ASTM A216 WCB.  
Diseño según API 600. Compuerta: ASTM A216 WCB + 13 Cr.  
Distancia entre bridas según ASME B16.10. Bridas según ASME B16.5. Temp. de trabajo: -20°C +400°C.

### Gate valve with flanged ends ANSI 150 class

Body and bonnet made of carbon steel ASTM A216 WCB.  
Design according to API 600. Gate: ASTM a216 WCB + 13 Cr.  
Face to face according to ASME B16.10. Flanged ends according to ASME B16.5. Working temperature: -20°C +400°C.

Medida/Size	DN	D	L	A	V
2"	50	150	178	405	200
2 1/2"	65	180	190	455	200
3"	80	190	203	505	250
4"	100	230	229	585	250
5"	125	255	254	680	300
6"	150	280	267	785	300
8"	200	345	292	955	350
10"	250	405	330	1175	400
12"	300	485	356	1365	450

2229A 09	2"	15,100	-
2229A 10	2 1/2"	21,250	-
2229A 11	3"	27,700	-
2229A 12	4"	42,100	-
2229A 13	5"	60,000	-
2229A 14	6"	68,000	-
2229A 16	8"	107,000	-
2229A 18	10"	177,125	-
2229A 20	12"	248,000	-

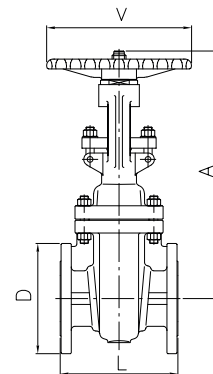

Ref. 2232N - 2232S



**Válvula de compuerta clase 800 (2232S-extremos S.W.)**

Const. cuerpo y bonete acero forjado ASTM A105N.  
Material de cierre: asiento con stellite.  
Compuerta: ASTM A182 - F6a. (trim #8/XU).  
Bonete atornillado. Extremos roscados NPT.

**Gate valve class 800 (2232S-S.W. ends)**

Body and bonnet made of forged steel ASTM A105N.  
Seat material: stainless steel stellited.  
Gate: astm a182 F6a (trim #8/XU). Bolted bonnet. NPT.  
Thread ends. (2232S- socket weld ends).

Max. working pressure: 140bar/ 2000 Psi  
Max. working temperature: 420°C / 788°F

Medida/Size	DN	d	SW	H	W	L
1/2"	15	10	21,8	151	100	79
3/4"	20	13,5	27,1	158	100	92
1"	25	18	33,8	185	125	111
1 1/4"	32	24	42,6	239	160	120
1 1/2"	40	30	48,7	243	160	120
2"	50	36,5	61,1	279	180	140

CÓDIGO CODE	MEDIDA SIZE	PESO WEIGHT	P.V.P. € PRICE €
2232N 04	1/2"	2,120	-
2232N 05	3/4"	2,309	-
2232N 06	1"	3,740	-
2232N 07	1 1/4"	5,465	-
2232N 08	1 1/2"	6,660	-
2232N 09	2"	10,422	-
2232S 04	1/2"	2,163	-
2232S 05	3/4"	2,314	-
2232S 06	1"	3,770	-
2232S 07	1 1/4"	5,504	-
2232S 08	1 1/2"	8,060	-
2232S 09	2"	10,240	-

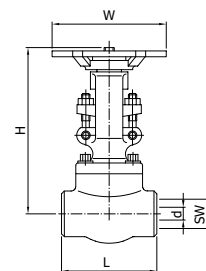

Ref. 2232A



**Válvula de compuerta con bridas ANSI clase 150**

Const. cuerpo y bonete acero forjado ASTM A105N.  
Material de cierre: asiento con stellite.  
Compuerta: ASTM A182 - F6a. (Trim #8/XU).  
Bonete atornillado.

**Gate valve with flanged ends ANSI 150 class**

Body and bonnet made of forged steel ASTM A105N.  
Seat material: stainless steel stellited.  
Gate: ASTM A182 F6a (Trim #8/XU). Bolted bonnet.

Max. working pressure: 19bar/ 275 Psi  
Max. working temperature: 420°C / 788°F

Medida/Size	DN	A	D	L	V
1/2"	15	157	90	108	80
3/4"	20	163	100	117	80
1"	25	194	110	127	105
1 1/4"	32	196	115	140	140
1 1/2"	40	217	125	165	140
2"	50	251	150	178	160

2232A 04	1/2"	3,400	-
2232A 05	3/4"	3,430	-
2232A 06	1"	5,697	-
2232A 07	1 1/4"	7,200	-
2232A 08	1 1/2"	9,400	-
2232A 09	2"	15,020	-

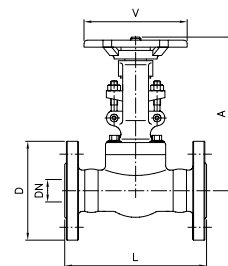

Ref. 2233N - 2233S



**Válvula de globo clase 800 (2233S - extremos S.W.)**

Const. cuerpo y bonete acero forjado ASTM A105N.  
Material de cierre: asiento con stellite.  
Disco: ASTM A182 - F6a. (trim #8/XU).  
Bonete atornillado. Extremos roscados NPT.

**Globe valve class 800 (2233S - S.W. ends)**

Body and bonnet made of forged steel ASTM A105N.  
Seat material: stainless steel stellited. Disc: ASTM A182 F6a (trim #8/XU). Bolted bonnet. NPT thread ends. (2233S socket weld ends).

Max. working pressure: 140bar/ 2000 Psi  
Max. working temperature: 420°C / 788°F

Medida/Size	DN	SW	H	W	L
1/2"	10	21,8	164	100	79
3/4"	13	27,1	164	100	92
1"	17	33,8	203	125	111
1 1/4"	23	42,6	224	160	120
1 1/2"	28	48,7	260	160	152
2"	36	61,1	300	180	172

2233N 04	1/2"	2,196	-
2233N 05	3/4"	2,330	-
2233N 06	1"	3,782	-
2233N 07	1 1/4"	5,200	-
2233N 08	1 1/2"	8,200	-
2233N 09	2"	12,500	-
2233S 04	1/2"	2,177	-
2233S 05	3/4"	2,340	-
2233S 06	1"	3,823	-
2233S 07	1 1/4"	5,332	-
2233S 08	1 1/2"	8,300	-
2233S 09	2"	12,700	-

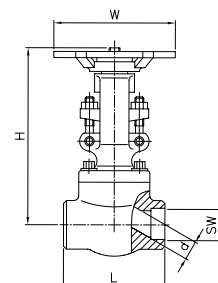

# LÍNEA INDUSTRIAL / INDUSTRIAL LINE

01 VÁLVULAS INDUSTRIALES INDUSTRIAL VALVES

Ref. 2233A



### Válvula de globo con bridas ANSI clase 150

Const. cuerpo y bonete acero forjado ASTM A105N.  
Material de cierre: asiento con stellite.  
Compuerta: ASTM A182 - F6a. (Trim #8/XU).  
Bonete atornillado.

### Globe valve with flanged ends ANSI 150 class

Body and bonnet made of forged steel ASTM A105N.  
Seat material: stainless steel stellited.  
Gate: ASTM A182 F6a (Trim #8/XU). Bolted bonnet.

Max. working pressure: 19bar/ 275 Psi  
Max. working temperature: 420°C / 788°F

Medida/Size	DN	A	D	L	V
1/2"	15	185	90	108	80
3/4"	20	183	100	117	80
1"	25	218	110	127	105
1 1/4"	32	223	115	140	140
1 1/2"	40	245	125	165	140
2"	50	269	150	203	160

CÓDIGO CODE	MEDIDA SIZE	PESO WEIGHT	P.V.P. € PRICE €
2233A 04	1/2"	3,230	-
2233A 05	3/4"	3,730	-
2233A 06	1"	5,950	-
2233A 07	1 1/4"	9,600	-
2233A 08	1 1/2"	9,820	-
2233A 09	2"	16,260	-

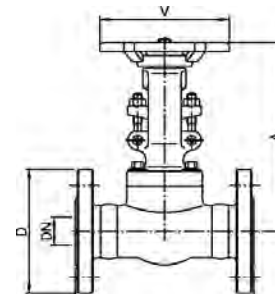

Ref. 2234N - 2234S



### Válvula de retención clase 800 tipo pistón (2234S - extremos S.W.)

Const. cuerpo y tapa acero forjado ASTM A105N.  
Material de cierre: asiento con stellite.  
Pistón: ASTM A182 - F6a. (trim #8/XU).  
Tapa atornillada. Extremos roscados NPT.

### Check valve class 800. Piston type (2234S- S.W ends)

Body and cover made of forged steel ASTM A105N.  
Seat material: stainless steel stellited.  
Piston: ASTM A182 F6a (trim #8/XU).  
Bolted cover. NPT thread ends.

Medida/Size	DN	SW	H	L
1/2"	15	21,8	61	79
3/4"	20	27,1	61	92
1"	25	33,8	78	111
1 1/4"	32	42,6	84	120
1 1/2"	40	48,7	101	120
2"	50	61,1	120	140

2234N 04	1/2"	1,555	-
2234N 05	3/4"	1,630	-
2234N 06	1"	2,750	-
2234N 07	1 1/4"	3,840	-
2234N 08	1 1/2"	5,500	-
2234N 09	2"	9,540	-
2234S 04	1/2"	1,527	-
2234S 05	3/4"	1,748	-
2234S 06	1"	3,037	-
2234S 07	1 1/4"	4,174	-
2234S 08	1 1/2"	6,370	-
2234S 09	2"	10,013	-

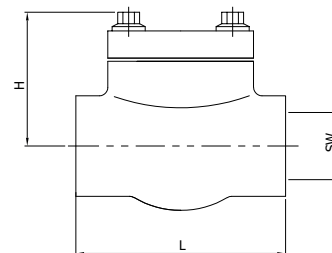

Ref. 2240



### Mirillas de turbulencia doble cristal

Construcción: cuerpo inox. AISI 316. Extremos rosca gas ISO 7-1 (EN 10226-1). Cristal: normal con tratamiento térmico bajo demanda: cristal "pyrex" (2240P). Presión máx. de trabajo: 16 BAR. Temp. máx. de trabajo: 160°C.

### Sight glass, double glass

Constr. body stainless steel AISI 316. Gas ISO 7-1 (EN 10226-1) threaded ends. Glass: normal with thermal treatment. On request: "pyrex" glass (2240P). Max. working pressure: 16 BAR. Max. working temp.: 160°C.

DN	L	A	B	C
15	100	70	64	40
20	100	70	64	40
25	120	88	72	50
32	120	88	72	50
40	150	123	96	65
50	150	123	96	65

2240 04	1/2"	1,132	-
2240 05	3/4"	1,042	-
2240 06	1"	1,489	-
2240 07	1 1/4"	1,563	-
2240 08	1 1/2"	3,587	-
2240 09	2"	3,613	-

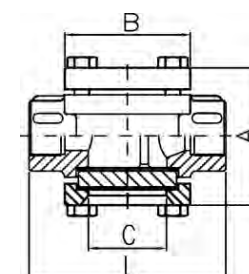

Ref. 2250



**Mirillas de turbulencia doble cristal**

Construcción: cuerpo inox. AISI 316. Extremos bridas din PN 16. Cristal: normal con tratamiento térmico. Bajo demanda: cristal "pyrex" (2250P). Presión máx. de trabajo: 16 BAR. Temp. máx. de trabajo: 160°C.

**Sight glass, double glass**

Constr. body stainless steel AISI 316. Ends: flanges din PN 16. Glass: normal with thermal treatment on request: "pyrex" glass (2250P). Max. working pressure: 16 BAR. Max. working temp: 160°C.

DN	L	A	B
15	130	95	40
20	150	105	40
25	160	115	50
32	180	140	50
40	200	150	65
50	230	165	65
65	290	185	100
80	310	200	100
100	350	220	125

CÓDIGO CODE	MEDIDA SIZE	PESO WEIGHT	P.V.P. € PRICE €
2250 04	1/2"	2,280	-
2250 05	3/4"	2,860	-
2250 06	1"	3,760	-
2250 07	1 1/4"	4,980	-
2250 08	1 1/2"	6,785	-
2250 09	2"	8,408	-
2250 10	2 1/2"	13,700	-
2250 11	3"	16,300	-
2250 12	4"	25,460	-

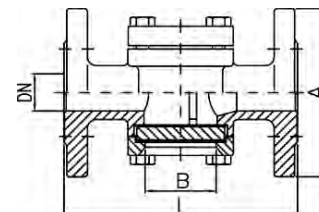

Ref. 2252 - 2252N



**Válvula de Seguridad**

Conexión rosca gas BSP M-H s/ ISO228/1, disponible con rosca NPT (2252N). Diseño, cálculo y control s/normas EN 12516 y EN 4126-1/7. Construcción: Acero Inoxidable 1.4408 (CF8M). Asiento y disco en acero inoxidable AISI 316. Tara entre 0,5 barg y 40 barg. Presión máxima de trabajo 40 bar. Temperatura de trabajo -20°C +300°C.

**Aplicación: Gases o vapor**

**Safety Valve**

BSP threaded ends acc./ ISO 228/1 M-F, available with NPT threaded (2252N). Design, calculations and control according to EN 12516 and EN 4126-1/7. Construction: Stainless steel 1.4408 (CF8M). Seat and disc in stainless steel AISI 316. Set pressure between 0,5 barg and 40 barg. Max. working pressure 40 bar. Working temperature -20°C +300°C.

**Applications: Gas or steam**

Medida/Size	PN	P	A	B	C	D
1/2" x 1"	40	13	59	129	35	45
3/4" x 1"	40	14	59	129	35	45
1" x 1"	40	16	59	129	35	45
1" x 1 1/4"	40	16	62	125	35	45
1" 1/4" x 1 1/4"	40	20	65	125	35	45
1 1/2" x 2"	40	28	81	206	46	65
2" x 2"	40	32	83	206	46	65

2252 04 06 XX	1/2" x 1"	1,360	-
2252 05 06 XX	3/4" x 1"	1,360	-
2252 06 06 XX	1" x 1"	1,360	-
2252 06 07 XX	1" x 1 1/4"	1,490	-
2252 07 07 XX	1 1/4" x 1 1/4"	1,535	-
2252 08 09 XX	1 1/2" x 2"	3,710	-
2252 09 09 XX	2" x 2"	3,780	-

**XX= Presión de seteo/taraje para definir muelle necesario / Setting pressure to define the necessary spring**

Precios rosca NPT a consultar / NPT thread prices on request

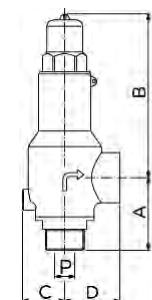

Ref. 2253 - 2253N



**Válvula de Seguridad**

Conexión rosca gas BSP M-H s/ ISO228/1, disponible con rosca NPT (2253N). Diseño, cálculo y control s/normas EN 12516 y EN 4126-1/7. Construcción: Acero inoxidable 1.4408 (CF8M). Asiento y disco en acero inoxidable AISI 316. Tara entre 0,5 barg y 40 barg. Presión máxima de trabajo 40 bar. Temperatura de trabajo -20°C +300°C. Palanca para abertura manual, caperuza abierta.

**Aplicación: Gases o vapor**

**Safety Valve**

BSP threaded ends acc./ ISO 228/1 M-F, available with NPT threaded (2253N). Design, calculations and control according to EN 12516 and EN 4126-1/7. Construction: Stainless steel 1.4408 (CF8M). Seat and disc in stainless steel AISI 316. Set pressure between 0,5 barg and 40 barg. Max. working pressure 40 bar. Working temperature -20°C +300°C. Lever for manual opening, open cap.

**Applications: Gas or steam**

Medida/Size	PN	P	A	B	C	D	H1	H2
1/2" x 1"	40	13	59	144	35	45	50	137
3/4" x 1"	40	14	59	144	35	45	50	137
1" x 1"	40	16	59	144	35	45	50	137
1" x 1 1/4"	40	16	62	141	35	45	50	137
1 1/4" x 1 1/4"	40	20	65	141	35	45	50	137
1 1/2" x 2"	40	28	81	226	46	65	50	196
2" x 2"	40	32	83	226	46	65	50	196

2253 04 06 XX	1/2" x 1"	1,445	-
2253 05 06 XX	3/4" x 1"	1,445	-
2253 06 06 XX	1" x 1"	1,445	-
2253 06 07 XX	1" x 1 1/4"	1,575	-
2253 07 07 XX	1 1/4" x 1 1/4"	1,620	-
2253 08 09 XX	1 1/2" x 2"	3,820	-
2253 09 09 XX	2" x 2"	3,890	-

**XX= Presión de seteo/taraje para definir muelle necesario / Setting pressure to define the necessary spring**

Precios rosca NPT a consultar / NPT thread prices on request

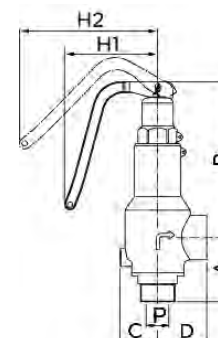

# LÍNEA INDUSTRIAL / INDUSTRIAL LINE

01 VÁLVULAS INDUSTRIALES INDUSTRIAL VALVES

Ref. 2256



### Válvula de Seguridad

Extremo bridado PN16/40 (entrada) según EN 1092-1 y rosca gas BSP s/ ISO228/1 (salida). Diseño, cálculo y control s/normas EN 12516 y EN 4126-1/7. Construcción: Acero Inoxidable 1.4408 (CF8M). Asiento y disco en acero inoxidable AISI 316. Tara entre 0,5 barg y 40 barg. Presión máxima de trabajo 40 bar. Temperatura de trabajo -20°C +300°C.

**Aplicación: Gases o vapor.**

### Safety Valve

Flanged end PN16/40 (inlet) acc. to EN 1092-1 and threaded end BSP acc. to ISO 228/1 (outlet). Design, calculations and control according to EN 12516 and EN 4126-1/7. Construction: Stainless steel 1.4408 (CF8M). Seat and disc in stainless steel

AISI 316. Set pressure between 0,5 barg and 40 barg. Max. working pressure 40 bar.

Working temperature -20°C +300°C.

**Applications: Gas or steam**

Medida/Size	PN	P	A	B	C	D	G
DN15 x 1"	16/40	13	87	129	35	45	95
DN20 x 1"	16/40	14	88	129	35	45	105
DN25 x 1"	16/40	16	94	129	35	45	115
DN25 x 1 1/4"	16/40	16	98	125	35	45	115
DN32 x 1 1/4"	16/40	20	102	125	35	45	140
DN40 x 2"	16/40	28	126	206	46	65	150
DN50 x 2"	16/40	32	127	206	46	65	165

CÓDIGO CODE	MEDIDA SIZE	PESO WEIGHT	P.V.P. € PRICE €
2256 04 06 XX	1/2" x 1"	2,180	-
2256 05 06 XX	3/4" x 1"	2,520	-
2256 06 06 XX	1" x 1"	2,840	-
2256 06 07 XX	1" x 1 1/4"	2,980	-
2256 07 07 XX	1 1/4" x 1 1/4"	3,900	-
2256 08 09 XX	1 1/2" x 2"	6,400	-
2256 09 09 XX	2" x 2"	7,310	-

**XX= Presión de seteo/taraje para definir muelle necesario / Setting pressure to define the necessary spring**

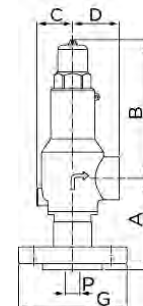

Ref. 2257



### Válvula de Seguridad

Extremo bridado PN16/40 (entrada) según EN 1092-1 y rosca gas BSP s/ ISO228/1 (salida). Diseño, cálculo y control s/normas EN 12516 y EN 4126-1/7. Construcción: Acero Inoxidable 1.4408 (CF8M). Asiento y disco en acero inoxidable AISI 316. Tara entre 0,5 barg y 40 barg. Presión máxima de trabajo 40 bar. Temperatura de trabajo -20°C +300°C. Palanca para apertura manual, caperuza abierta.

**Aplicación: Gases o vapor.**

### Safety Valve

Flanged end PN16/40 (inlet) acc. to EN 1092-1 and threaded end BSP acc. to ISO 228/1 (outlet). Design, calculations and control according to EN 12516 and EN 4126-1/7. Construction: Stainless steel 1.4408 (CF8M). Seat and disc in stainless steel

AISI 316. Set pressure between 0,5 barg and 40 barg. Max. working pressure 40 bar. Working temperature -20°C +300°C. Lever for manual opening, open cap.

**Applications: Gas or steam**

Medida/Size	PN	P	A	B	C	D	G	H1	H2
DN15 x 1"	16/40	13	87	144	35	45	95	50	137
DN20 x 1"	16/40	14	88	144	35	45	105	50	137
DN25 x 1"	16/40	16	94	144	35	45	115	50	137
DN25 x 1 1/4"	16/40	16	98	141	35	45	115	50	137
DN32 x 1 1/4"	16/40	20	102	141	35	45	140	50	137
DN40 x 2"	16/40	28	126	226	46	65	150	50	196
DN50 x 2"	16/40	32	127	226	46	65	165	50	196

2257 04 06 XX	1/2" x 1"	2,266	-
2257 05 06 XX	3/4" x 1"	2,605	-
2257 06 06 XX	1" x 1"	2,925	-
2257 06 07 XX	1" x 1 1/4"	3,065	-
2257 07 07 XX	1 1/4" x 1 1/4"	3,990	-
2257 08 09 XX	1 1/2" x 2"	6,520	-
2257 09 09 XX	2" x 2"	7,420	-

**XX= Presión de seteo/taraje para definir muelle necesario / Setting pressure to define the necessary spring**

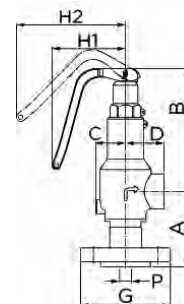

Ref. 2258 - 2258N

**NEW**



### Válvula de Alivio de Presión.

Conexión rosca gas BSP M-H s/ISO 7-1, disponible con rosca NPT (2258N). Construcción: Acero Inoxidable 1.4408 (CF8M). Cierre PTFE. Tara entre 0,5 barg y 25 barg. Presión máxima de trabajo 25 bar. Temperatura de trabajo -20°C +200°C.

### Pressure relief valve.

BSP threaded ends acc./ ISO 7-1 M-F, available with NPT threaded (2258N). Construction: Stainless steel 1.4408 (CF8M). PTFE sealing. Set pressure between 0,5 barg and 25 barg. Max. working pressure 25 bar. Working temperature -20°C +200°C.

Medida/Size	PN	P	A	B	C	D
1/2" x 1"	25	13	59	134	35	45
3/4" x 1"	25	14	59	134	35	45
1" x 1"	25	16	59	134	35	45
1" x 1 1/4"	25	16	62	131	35	45
1 1/4" x 1 1/4"	25	20	65	131	35	45
1 1/2" x 2"	25	28	81	191	46	65
2" x 2"	25	32	83	191	46	65

2258 04 06 XX	1/2" x 1"	1,350	-
2258 05 06 XX	3/4" x 1"	1,350	-
2258 06 06 XX	1" x 1"	1,350	-
2258 06 07 XX	1" x 1 1/4"	1,480	-
2258 07 07 XX	1 1/4" x 1 1/4"	1,520	-
2258 08 09 XX	1 1/2" x 2"	3,700	-
2258 09 09 XX	2" x 2"	3,760	-

**XX= Presión de seteo/taraje para definir muelle necesario / Setting pressure to define the necessary spring**

Precios rosca NPT a consultar / NPT thread prices on request

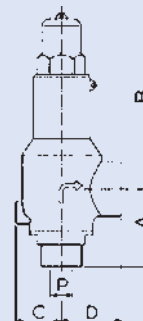



Ref.2259

**NEW**

**Válvula de Alivio de Presión.**

Extremo bridado PN25 (entrada) según EN 1092-1 y rosca gas BSP s/ ISO228/1 (salida). Construcción: Acero Inoxidable 1.4408 (CF8M). Cierre PTFE. Tara entre 0,5 barg y 25 barg. Presión máxima de trabajo 25 bar. Temperatura de trabajo -20°C +200°C.

**Pressure relief valve.**

Flanged end PN25 (inlet) acc. to EN 1092-1 and threaded end BSP acc. to ISO 228/1 (outlet). Construction: Stainless steel 1.4408 (CF8M). PTFE sealing. Set pressure between 0,5 barg and 25 barg. Max. working pressure 25 bar. Working temperature -20°C +200°C.



Medida/Size	PN	P	A	B	C	D	G
DN15 x 1"	25	13	87	129	35	45	95
DN20 x 1"	25	14	88	129	35	45	105
DN25 x 1"	25	16	94	129	35	45	115
DN25 x 1 1/4"	25	16	98	125	35	45	115
DN32 x 1	25	20	102	125	35	45	140
DN40 x 2"	25	28	126	206	46	65	150
DN50 x 2"	25	32	127	206	46	65	165

CÓDIGO CODE	MEDIDA SIZE	PESO WEIGHT	P.V.P. € PRICE €
2259 04 06 XX	1/2" x 1"	2,170	-
2259 05 06 XX	3/4" x 1"	2,510	-
2259 06 06 XX	1" x 1"	2,830	-
2259 06 07 XX	1" x 1 1/4"	2,960	-
2259 07 07 XX	1 1/4" x 1 1/4"	3,870	-
2259 08 09 XX	1 1/2" x 2"	6,380	-
2259 09 09 XX	2" x 2"	7,290	-

**XX= Presión de seteo/taraje para definir muelle necesario / Setting pressure to define the necessary spring**

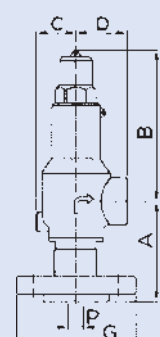

Ref. 2272

**Válvula reductora de presión**

Construcción: acero inox. CF8M (316) microfundición. Extremos rosca gas ISO 228-1. Asiento y diafragma FPM (Viton). Presión máxima de entrada 25 bar. Presión de salida: 1 - 6 bar (tarado a 3 bar). Temperatura de trabajo: -15°C +120°C.

**Stainless steel pressure reducing valve**

Construction: stainless steel CF8M (316) investment casting. Gas threaded ends ISO 228-1. Seat and diaphragm in FPM (viton). Maxim input pressure 25 bar.

Outlet pressure: 1 - 6 bar (preset 3 bar). Working temperature: -15°C +120°C.



DN	R	H	L
15	1/2"	100	70
20	3/4"	100	85
25	1"	105	92

2272 04	1/2"	0,780	-
2272 05	3/4"	1,010	-
2272 06	1"	1,160	-

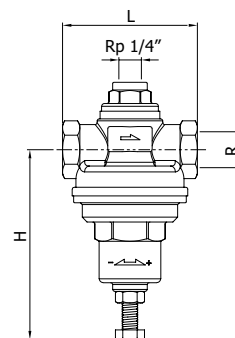

Ref.2274 - 2274N

**NEW**

**Válvula Reductora de Presión pilotada.**

Conexión rosca gas s/ISO 7-1, disponible con rosca NPT (2274N). Construcción: Acero al Carbono 1.0619 (WCB). Presión de entrada máxima 25 bar. Presión de salida desde 0,5 a 12 bar. Temperatura máxima de trabajo 260°C.

**Pilot operated Pressure Reducing Valve.**

Threaded ends acc. to ISO 7-1, available with NPT threaded (2274N). Construction: Carbon steel 1.0619 (WCB). Maximum input pressure 25 bar. Outlet pressure from 0,5 to 12 bar. Maximum working temperature 260°C.



Medida/Size	PN	L	H	H1	D
1/2"	25	147	150	302	185
3/4"	25	150	155	302	185
1"	25	160	165	308	210
1 1/4"	25	180	175	308	210
1 1/2"	25	200	196	316	255
2"	25	230	205	324	255

2274 04	1/2"	14,300	-
2274 05	3/4"	14,600	-
2274 06	1"	17,100	-
2274 07	1 1/4"	18,300	-
2274 08	1 1/2"	27,100	-
2274 09	2"	30,600	-

Precios rosca NPT a consultar / NPT thread prices on request

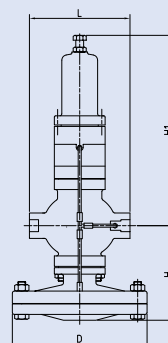

# LÍNEA INDUSTRIAL / INDUSTRIAL LINE

Ref.2275

**NEW**



### Válvula Reductora de Presión pilotada.

Extremos bridados según EN 1092-1 PN25.  
 Construcción: Acero al Carbono 1.0619 (WCB). Presión de entrada máxima 25 bar. Presión de salida desde 0,5 a 12 bar. Temperatura máxima de trabajo 260°C.

### Pilot operated Pressure Reducing Valve.

Flanged ends according to EN 1092-1 PN25.  
 Construction: Carbon steel 1.0619 (WCB). Maximum input pressure 25 bar. Outlet pressure from 0,5 to 12 bar. Maximum working temperature 260°C.

DN	PN	L	H	H1	D
15	25	147	150	302	185
20	25	150	155	302	185
25	25	160	165	308	210
32	25	180	175	308	210
40	25	200	196	316	255
50	25	230	205	324	255

CÓDIGO CODE	MEDIDA SIZE	PESO WEIGHT	P.V.P. € PRICE €
2275 04	1/2"	15,650	-
2275 05	3/4"	16,200	-
2275 06	1"	19,158	-
2275 07	1 1/4"	22,000	-
2275 08	1 1/2"	31,000	-
2275 09	2"	35,900	-

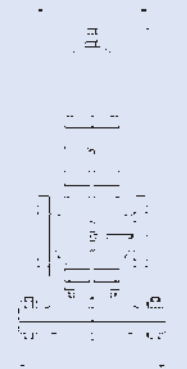

Ref.2281

**NEW**



### Válvula Reductora de Presión.

Conexión rosca gas s/ISO 7-1. Construcción: Acero inox. CF8 (304).  
 Presión de entrada máxima 16 bar. Presión de salida desde 2 a 8 bar.  
 Temperatura máxima de trabajo 200°C.

### Pressure Reducing Valve.

BSP threaded ends acc. to ISO 7-1. Construction: stainless steel CF8 (304).  
 Maximum input pressure 16 bar. Outlet pressure from 2 to 8 bar.  
 Maximum working temperature 200°C.

Medida/Size	PN	L	H	H1
1/2"	16	85	140	52
3/4"	16	95	143	55
1"	16	105	146	58

2281 04	1/2"	1,425	-
2281 05	3/4"	1,650	-
2281 06	1"	1,850	-

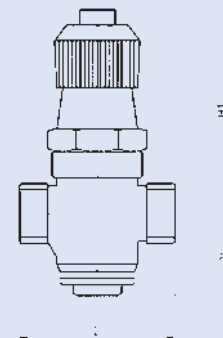

Ref. 2282 - 2282N



### Purgador termodinámico con filtro incorporado para vapor

PN 63. Const.: acero inox. 420 (ASTM A743 Gr-CA40).  
 Tamiz: AISI 304. Extremos: rosca gas ISO 228-1.  
 También disponible con rosca NPT.  
 PMO: 52 bar. TMO: 400°C.

### Thermodynamic steam trap with strainer

PN 63. Const. stainless steel 420 (ASTM A743 Gr-CA40).  
 Strainer screen: AISI 304. Gas Threaded ends ISO 228-1.  
 Also available with NPT Threaded.  
 PMO: 52 bar. TMO: 400°C.

Medida/Size	A1	A2	L
1/2"	41	57	78
3/4"	46	60	90
1"	54	65	95

2282 04	1/2"	0,848	-
2282 05	3/4"	1,162	-
2282 06	1"	1,593	-

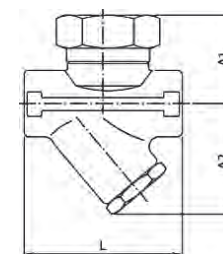

Ref. 2284 - 2284N



### Purgador termodinámico sin filtro para vapor

PN 63. Const.: acero inox. 420 (ASTM A743 Gr-CA40).  
 Extremos: rosca gas ISO 228-1.  
 También disponible con rosca NPT.  
 PMO: 52 bar. TMO: 400°C.

### Thermodynamic steam trap without strainer

PN 63. Const. stainless steel 420 (ASTM A743 Gr-CA40).  
 Gas threaded ends ISO 228-1.  
 Also available with NPT Threaded.  
 PMO: 52 bar. TMO: 400°C.

Medida/Size	A	L
1/2"	40	70
3/4"	43	80
1"	52	90

2284 04	1/2"	0,500	-
2284 05	3/4"	0,760	-
2284 06	1"	1,203	-

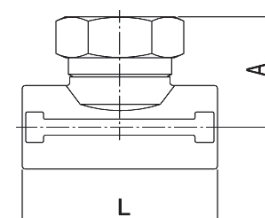

Ref. 2285 - 2285N



**Purgador de boya cerrada para vapor**

Conexión rosca gas BSP s/ISO 228/1, disponible con rosca NPT (2285N). Construcción: Acero al Carbono 1.0619 (WCB). Partes internas en acero inoxidable. Eliminador termostático de aire interno. Instalación horizontal. Máxima presión de trabajo PN16. Presión diferencial máxima: 4,5 bar (045) ó 10 bar (100). Temperatura máxima de trabajo 250°C.

**Ball float steam trap**

BSP threaded ends acc. to ISO 228/1, available with NPT threaded (2285N). Construction: Carbon steel 1.0619 (WCB). Internal parts made of stainless steel. Internal air vent assembly. Horizontal installation. Maximum working pressure PN16. Maximum differential pressure: 4,5 bar (045) or 10 bar (100). Maximum working temperature 250°C.

Medida/Size	PN	A	B	C	D
1/2"	16	121	107	75	158
1/2"	16	121	107	75	158
3/4"	16	121	107	75	158
1"	16	145	107	75	166
1"	16	145	107	67	166

CÓDIGO CODE	MEDIDA SIZE	PESO WEIGHT	P.V.P. € PRICE €
2285 04 045	1/2"	3,200	-
2285 04 100	1/2"	3,200	-
2285 05 045	3/4"	3,500	-
2285 05 100	3/4"	3,500	-
2285 06 045	1"	4,600	-
2285 06 100	1"	4,600	-

Precios rosca NPT a consultar / NPT thread prices on request

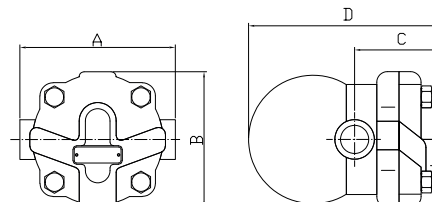

Ref. 2286



**Purgador de boya cerrada para vapor**

Extremos bridados según EN 1092-1 PN16. Construcción: Acero al Carbono 1.0619 (WCB). Partes internas en acero inoxidable. Eliminador termostático de aire interno. Instalación horizontal. Máxima presión de trabajo PN16. Presión diferencial máxima: 4,5 bar (045) ó 10 bar (100). Temperatura máxima de trabajo 250°C.

**Ball float steam trap**

Flanged ends according to EN 1092-1 PN16. Construction: Carbon steel 1.0619 (WCB). Internal parts made of stainless steel. Internal air vent assembly. Horizontal installation. Maximum working pressure PN16. Maximum differential pressure: 4,5 bar (045) or 10 bar (100). Maximum working temperature 250°C.

Medida/Size	PN	A	B	C	D
1/2"	16	150	95	75	90
3/4"	16	150	105	75	90
1"	16	160	115	70	104

2286 04 045	1/2"	5,400	-
2286 04 100	1/2"	5,400	-
2286 05 045	3/4"	5,700	-
2286 05 100	3/4"	5,730	-
2286 06 045	1"	6,500	-
2286 06 100	1"	6,500	-

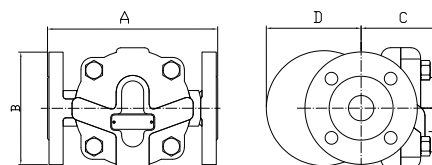

Ref. 2287



**Purgador de boya cerrada para vapor (alta capacidad de descarga)**

Extremos bridados según EN 1092-1 PN16. Construcción: Acero al Carbono 1.0619 (WCB). Partes internas en acero inoxidable. Eliminador termostático de aire interno. Instalación horizontal. DN25: asiento simple, DN40/50: Asiento doble. Máxima presión de trabajo PN16. Presión diferencial máxima: 4,5 bar (045) ó 10 bar (100). Temperatura máxima de trabajo 250°C.

**Ball float steam trap (high capacity discharge)**

Flanged ends according to EN 1092-1 PN16. Construction: Carbon steel 1.0619 (WCB). Internal parts made of stainless steel. Internal air vent assembly. Horizontal installation. DN25: Single seat, DN40/50: Double seat. Maximum working pressure PN16. Maximum differential pressure: 4,5 bar (045) or 10 bar (100). Maximum working temperature 250°C.

Medida/Size	PN	A	B	C	D
1"	16	160	105	70	250
1 1/2"	16	230	120	92	317
2"	16	230	140	125	330

2287 06 045	1"	9,500	-
2287 06 100	1"	9,500	-
2287 08 045	1 1/2"	27,000	-
2287 08 100	1 1/2"	27,000	-
2287 09 045	2"	29,500	-
2287 09 100	2"	29,500	-

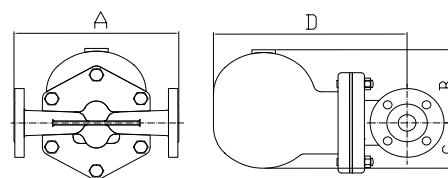

Ref. 2401



**Tipo wafer. Válvula retención doble disco PN 16**

Construcción: cuerpo hierro fundido GG-25. Discos inox 316. Ejes y resortes: AISI 316. Cojinetes: PTFE. Montaje entre bridas PN 10/16 - ANSI 150 lbs. Asiento nitrilo vulcanizado en ranura.

**Wafer type. Double disk check valve PN 16**

Body: cast iron GG 25. Disks stainless steel316. Stem and spring: AISI 316. Bearings: PTFE. Mounting between flanges PN 10/16 - ANSI 150 lbs. Seat: nitrile vulcanised in the slot.

DN	A	B	C	D
50	101	54	66	27
65	120	54	78	27
80	133	57	89	28
100	164	64	117	30
125	194	70	141	31
150	220	76	168	31
200	275	95	210	41
250	330	108	265	41
300	380	143	311	46

2401 09	2"	1,510	-
2401 10	2 1/2"	1,990	-
2401 11	3"	2,720	-
2401 12	4"	4,090	-
2401 13	5"	6,300	-
2401 14	6"	8,283	-
2401 16	8"	16,011	-
2401 18	10"	23,700	-
2401 20	12"	41,767	-

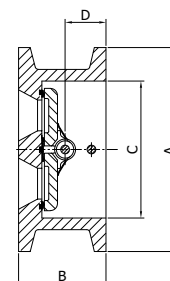

# LÍNEA INDUSTRIAL / INDUSTRIAL LINE

Ref. 2402



**Tipo wafer. Válvula retención doble disco PN 25**

Const.: AISI 316. Cojinetes PTFE - asiento vitón. Montaje entre bridas PN 25 - ANSI 150 lbs. Asiento vitón vulcanizado en ranura.

**Wafer type. Double disk check valve PN 25**

Const: AISI 316. Bearings: PTFE. Mounting between flanges PN 25- ANSI 150 lbs. Seat: vitón vulcanised in the slot.

DN	A	B	C	D
50	101	54	60	27
65	120	54	73	27
80	133	57	89	28
100	170	64	114	30
125	196	70	141	31
150	226	76	168	31
200	288	95	219	41
250	343	108	273	41
300	403	143	324	46

CÓDIGO CODE	MEDIDA SIZE	PESO WEIGHT	P.V.P. € PRICE €
2402 09	2"	1,400	-
2402 10	2 1/2"	1,850	-
2402 11	3"	2,360	-
2402 12	4"	3,900	-
2402 13	5"	6,230	-
2402 14	6"	8,040	-
2402 16	8"	15,710	-
2402 18	10"	20,500	-
2402 20	12"	33,950	-

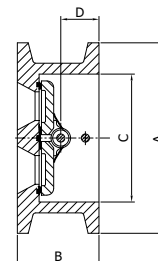

Ref. 2406



**Tipo wafer. Válvula de retención a clapeta DIN PN 16**

Cuerpo y disco acero INOX 316. Junta tórica: vitón montaje entre bridas PN 10/16 - ANSI 150 lbs.

**Wafer type. Disk check valve din PN 16**

Body and disk in stainless steel AISI 316. O'ring: viton. Mounting between flanges PN 10/16 - ANSI 150 lbs.

DN	d	D	S
40	25	85	12
50	32	105	14
65	40	124	14
80	54	136	14
100	70	164	18
125	92	194	18
150	114	220	20
200	154	275	22
250	200	330	26
300	230	384	30

2406 08	1 1/2"	0,452	-
2406 09	2"	0,788	-
2406 10	2 1/2"	1,063	-
2406 11	3"	1,243	-
2406 12	4"	2,255	-
2406 13	5"	3,115	-
2406 14	6"	4,576	-
2406 16	8"	7,560	-
2406 18	10"	12,473	-
2406 20	12"	19,330	-

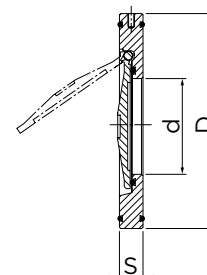

Ref. 2415



**Tipo Wafer. Válvula retención disco PN 40 ≤ 100. PN 25 > DN100**

Construcción: AISI 316. disco y resorte: AISI 316. Montaje entre bridas PN 10/40. ANSI 150 lbs. Longitud s/DIN 3202 K4.

**Wafer type. Disk check valve PN 40 ≤ 100. PN 25 > DN100**

Constr.: AISI 316. Disk and spring: AISI 316. Mounting between flanges PN 10/40. ANSI 150 lbs. Length: DIN 3202 K4.

DN	PN	D	B	A	L
15	40	39	15	34	16
20	40	46	20	41	19
25	40	54	25	49	22
32	40	70	32	62	28
40	40	81	40	71	32
50	40	94	48	85	40
65	40	113	62	102	46
80	40	132	75	123	50
100	40	150	95	140	60
125	25	187	118	177	90
150	25	217	140	205	106
200	25	274	185	261	140

2415 04	1/2"	0,085	-
2415 05	3/4"	0,122	-
2415 06	1"	0,206	-
2415 07	1 1/4"	0,342	-
2415 08	1 1/2"	0,525	-
2415 09	2"	0,775	-
2415 10	2 1/2"	1,245	-
2415 11	3"	1,891	-
2415 12	4"	2,758	-
2415 13	5"	5,558	-
2415 14	6"	8,550	-
2415 16	8"	16,100	-

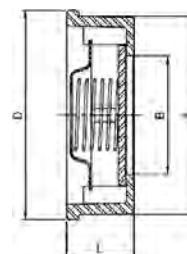

Ref. 2413



**Válvula de retención a disco PN 63**

Construcción: acero inox. CF8M (316) microfundición. Extremos: rosca gas ISO 7-1 (EN 10226-1). Asiento: PTFE. PN 63, temp: -20°C +200°C.

**Disk check valve PN 63**

Const. stainless steel CF8M (316) investment casting. Gas threaded ends ISO 7-1 (EN 10226-1). Seat: PTFE. PN 63, temp: -20°C +200°C.

DN	R	B	C
15	1/2"	37	56
20	3/4"	42	63
25	1"	48	74

CÓDIGO CODE	MEDIDA SIZE	PESO WEIGHT	CAJA / BOX CARTON	P.V.P. € PRICE €
-------------	-------------	-------------	-------------------	------------------

2413 04	1/2"	0,210	10-120	-
2413 05	3/4"	0,305	6-72	-
2413 06	1"	0,400	4-48	-

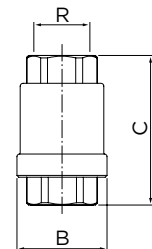

Ref. 2416 - 2416N



**Válvula de retención a disco PN 63**

Construcción: acero inox. CF8M (316) microfundición. Extremos: rosca gas ISO 7-1 (EN 10226-1). Disco y resorte: AISI 316. PN 63, temp: -20°C +240°C.

**Disk check valve PN 63**

Const. stainless steel CF8M (316) investment casting. Gas threaded ends ISO 7-1 (EN 10226-1). Disk and spring: AISI 316. PN 63, Temp: -20°C +240°C.

DN	R	B	C
8	1/4"	30,5	53
10	3/8"	30,5	53
15	1/2"	37	56
20	3/4"	42	63
25	1"	48	74
32	1 1/4"	58	81
40	1 1/2"	70	91
50	2"	82	97
65	2 1/2"	102,5	118
80	3"	120	138
100	4"	150	158

2416 02	1/4"	0,165	10-120	-
2416 03	3/8"	0,151	10-120	-
2416 04	1/2"	0,210	10-120	-

2416 05	3/4"	0,280	6-72	-
2416 06	1"	0,386	4-48	-
2416 07	1 1/4"	0,660	4-48	-
2416 08	1 1/2"	0,970	2-24	-
2416 09	2"	1,400	1-12	-
2416 10	2 1/2"	2,577	5-10	-
2416 11	3"	4,010	3-6	-
2416 12	4"	6,925	-	-

Precios rosca NPT a consultar / NPT thread prices on request

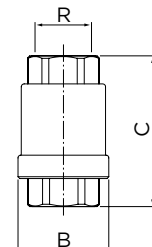

Ref. 2417



**Válvula retención a bola**

Construcción: cuerpo en acero inox AISI 316. Bola en aluminio recubierta en NBR. Extremos rosca gas PN 16. Temp.: 0°C +90°C.

**Ball check valve**

Body: stainless steel AISI 316. Ball: aluminium +NBR. Gas threaded ends, PN 16. Temp.: 0°C +90°C.

Medida/Size	A	B
1 1/4"	175	99
1 1/2"	190	99
2"	210	112

CÓDIGO CODE	MEDIDA SIZE	PESO WEIGHT	P.V.P. € PRICE €
-------------	-------------	-------------	------------------

2417 07	1 1/4"	1,100	-
2417 08	1 1/2"	1,150	-
2417 09	2"	1,600	-

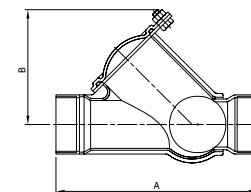

Ref. 2430 - 2430N



**Válvula retención a clapeta oscilante PN 16 (2430N - Rosca NPT)**

Construcción: inox. CF8M (316) microfundición. Juntas: PTFE conexión: rosca gas ISO 7-1. Presión máx.: 16 kg/cm2 a 120°C - 10 kg/cm2 a 180°C. Temp. mín.: -30°C.

**Swing check valve PN 16 (2430N - NPT thread)**

Constr. stainless steel CF8M (316) investment casting. Seals: PTFE: gas threaded ends ISO 7-1. Max. pressure: 16 kg/cm2 at 120°C - 10 kg/cm2 at 180°C. Min. temp.: -30°C.

R	DN	L	H
1/2"	15	65	44
3/4"	20	80	53
1"	25	90	58
1 1/4"	32	105	62
1 1/2"	40	120	73
2"	50	141	78

2430 04	1/2"	0,330	-
2430 05	3/4"	0,530	-
2430 06	1"	0,745	-
2430 07	1 1/4"	1,042	-
2430 08	1 1/2"	1,590	-
2430 09	2"	2,275	-

Precios rosca NPT a consultar / NPT thread prices on request

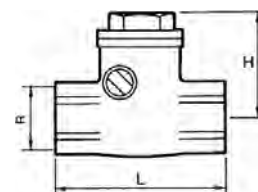

# LÍNEA INDUSTRIAL / INDUSTRIAL LINE

01 VÁLVULAS INDUSTRIALES INDUSTRIAL VALVES

Ref. 2435



### Válvula de retención- "Idrja"

Construcción: AISI 304 - Asiento vitón. Extremos Victaulic.  
Temperatura de trabajo: -25°C + 150°C  
Presión de trabajo: 16bar. Presión de apertura: 0,03 bar.

### Check valve - "Idrja"

Constr. AISI 304. Viton seat. Victaulic ends.  
Working temperature: -25°C + 150°C.  
Working pressure: 16 bar. Opening pressure: 0,03 bar.

Medida/Size	A	B	C	D	E
1"	118,4	30	33,7	15,9	8
1 1/4"	124,1	38,8	42,4	15,9	8
1 1/2"	140,7	44,9	48,3	15,9	8
2"	160,9	57	60,3	15,9	8

CÓDIGO CODE	MEDIDA SIZE	PESO WEIGHT	P.V.P. € PRICE €
-------------	-------------	-------------	------------------

2435 06	1"	-	-
2435 07	1 1/4"	0,385	-
2435 08	1 1/2"	-	-
2435 09	2"	0,86	-

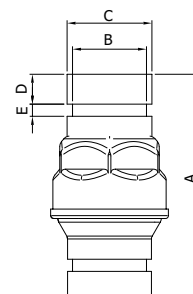

Ref. 2440 - 2440N



### Válvula retención "Cromax" - "Idrja"

También disponible con rosca NPT (2440N)  
Construcción: AISI 304 - asiento vitón. Extremos roscados ISO 228. Temp. de trabajo, mín. -25°C máx. +150°C. Presión de trabajo, 16 bar. Presión de apertura, 0,03 bar.

### "Cromax" check valve "Idrja"

Also available NPT thread (2440N)  
Constr.: AISI 304 - viton seat. Gas threaded ends ISO 228.  
Working temp. min. -25°C +150°C. Working pressure: 16 bar.  
Opening pressure: 0.03 bar.

### Válvula retención "Cromax" - "Idrja" NPT

### "Cromax" check valve "Idrja" NPT thread

DN	A	B	C
8	18	55	32
12	20	55	32
15	25	55	32
20	30	67	44
25	36	83	53
32	45	97	62
40	51	115	78
50	63	121	89
65	80	141	113

2440 02	1/4"	0,106	-
2440 03	3/8"	0,091	-
2440 04	1/2"	0,093	-
2440 05	3/4"	0,129	-
2440 06	1"	0,191	-
2440 07	1 1/4"	0,281	-
2440 08	1 1/2"	0,388	-
2440 09	2"	0,704	-
2440 10	2 1/2"	1,425	-

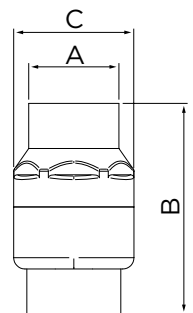

Ref. 2442



### Filtro válvula retención inox 304

Construcción: AISI 304 malla AISI 304. Extremos roscados. Gas exterior PN 16 bar. Diámetro malla: 1/2" a 2": máx. 1 mm - 2 1/2" a 4": máx. 1,9 mm.

### Strainer for check valve

Const. stainless steel AISI 304. Sieve AISI 304, external gas. Threaded ends PN 16 bar. Sieve diameter: 1/2" to 2": max. 1 mm - 2 1/2" to 4": max. 1,9 mm.

A	B	C	D	E	F	G	H
1/2"	56,5	17,5	22	23	4	10	15
3/4"	62,5	22	28	29	4	10	15
1"	70	28,5	36	37	4	10	15
1 1/4"	80	36,5	43	44	5	14	20
1 1/2"	90	42,5	48	49	5	14	20
2"	100	54,5	61	62	5,5	14	20
2 1/2"	115	70,5	79,5	80,5	5,5	16	25
3"	125	83	92	93	6	16	25
4"	145	108,5	116	117	6	16	25

2442 04	1/2"	0,021	-
2442 05	3/4"	0,022	-
2442 06	1"	0,034	-
2442 07	1 1/4"	0,054	-
2442 08	1 1/2"	0,064	-
2442 09	2"	0,085	-
2442 10	2 1/2"	0,147	-
2442 11	3"	0,785	-
2442 12	4"	0,260	-

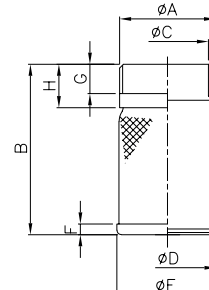

Ref. 2445



**Válvula retención "Cromax" - "Idrja"**

Construcción: AISI 316 - asiento vitón. Extremos rosca gas ISO 228. Temp. de trabajo, mín. -25°C - máx. +150°C. Presión de trabajo, 16 bar. Presión de apertura, 0,03 bar.

**"Cromax" check valve "Idrja"**

Constr.: AISI 316 - seat viton. Gas threaded ends ISO 228. Working temp. min. -25°C max. +150°C. Working pressure: 16 bar. Opening pressure: 0.03 bar.

DN	A	B	C
8	25	55	32
12	25	55	32
15	25	55	32
20	30	67	44
25	36	83	53
32	45	97	62
40	51	115	78
50	63	121	89
65	80	141	113
80	93	164	132
100	120	191	167

CÓDIGO CODE	MEDIDA SIZE	PESO WEIGHT	P.V.P. € PRICE €
2445 02	1/4"	0,100	-
2445 03	3/8"	0,091	-
2445 04	1/2"	0,095	-
2445 05	3/4"	0,129	-
2445 06	1"	0,200	-
2445 07	1 1/4"	0,300	-
2445 08	1 1/2"	0,388	-
2445 09	2"	0,704	-
2445 10	2 1/2"	1,425	-
2445 11	3"	2,085	-
2445 12	4"	3,415	-

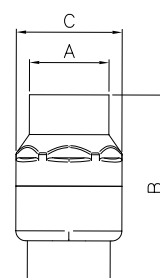

Ref. 2447



**Filtro válvula retención**

Construcción: AISI 316 malla AISI 316. Extremos roscado gas exterior PN 16 bar. Diámetro malla: 1/2" a 2": máx. 1 mm - 2 1/2" a 4": máx. 1,9 mm.

**Strainer for check valve**

Const.: sieve stainless steel AISI 316. Steel AISI 316. External gas threaded ends PN 16 bar. Sieve diameter: 1/2" to 2": max. 1 mm. 2 1/2" to 4": max. 1,9 mm.

A	B	C	D	E	F	G	H
1/2"	56,5	17,5	22	23	4	10	15
3/4"	62,5	22	28	29	4	10	15
1"	70	28,5	36	37	4	10	15
1 1/4"	80	36,5	43	44	5	14	20
1 1/2"	90	42,5	48	49	5	14	20
2"	100	54,5	61	62	5,5	14	20
2 1/2"	115	70,5	79,5	80,5	5,5	16	25
3"	125	83	92	93	6	16	25
4"	145	108,5	116	117	6	16	25

2447 04	1/2"	0,016	-
2447 05	3/4"	0,022	-
2447 06	1"	0,034	-
2447 07	1 1/4"	0,054	-
2447 08	1 1/2"	1,065	-
2447 09	2"	0,085	-
2447 10	2 1/2"	0,136	-
2447 11	3"	0,195	-
2447 12	4"	0,250	-

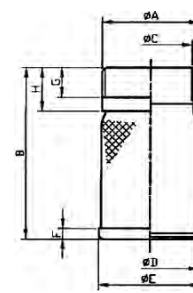

Ref. 2448



**Válvula de retención de pie con brida DIN PN 16**

Construcción en acero inoxidable 316 (CF8M). Asiento de vitón, junta PTFE. Con sistema manual de vaciado. Presión máxima de trabajo 16 bar.

**Foot check valve with DIN PN 16 flange end**

Stainless steel material AISI 316 (CF8M). Seat viton material, gasket PTFE. With manual system to empty. Max. working pressure 16 bar.

Medida/Size	DN	D	L
2"	50	165	170
2 1/2"	65	185	183
3"	80	200	198
4"	100	220	242
5"	125	250	282
6"	150	285	326
8"	200	340	440

2448 09	2"	4,680	-
2448 10	2 1/2"	6,900	-
2448 11	3"	9,284	-
2448 12	4"	12,947	-
2448 13	5"	19,870	-
2448 14	6"	28,172	-
2448 16	8"	52,865	-

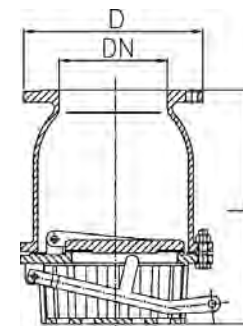

# LÍNEA INDUSTRIAL / INDUSTRIAL LINE

01 VÁLVULAS INDUSTRIALES INDUSTRIAL VALVES

Ref. 2450



### Válvula retención a disco con bridas DIN PN 16

Cuerpo: fund. hierro GG-25. Disco: fund. hierro GG-25. Guía: DN 50-80 latón DIN -17660. Guía: DN 100-250 fund. GG-25. Soporte: latón DIN 17660. Cierre blando: NBR 80 SH.

### Disk check valve with flanges DIN PN 16

Body and disk: cast iron GG-25. Guide: DN 50-80 brass DIN 17660. Guide: DN 100-250 cast iron GG-25. Bracket: brass DIN 17660. Locking device: NBR 80 SH.

Medida/Size	Ø	B	C
2"	51	165	100
2 1/2"	63	185	120
3"	80	200	140
4"	100	220	170
5"	125	250	200
6"	150	285	230
8"	200	340	300
10"	250	405	370

CÓDIGO CODE	MEDIDA SIZE	PESO WEIGHT	P.V.P. € PRICE €
2450 09	2"	5,075	-
2450 10	2 1/2"	7,730	-
2450 11	3"	9,542	-
2450 12	4"	12,550	-
2450 13	5"	20,135	-
2450 14	6"	27,944	-
2450 16	8"	47,000	-
2450 18	10"	69,500	-

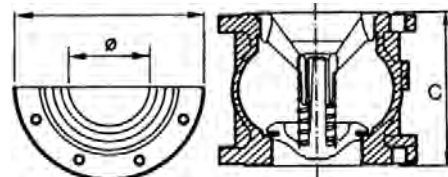

Ref. 2451



### Filtro colador para ensamblar - brida PN 16

Construcción acero zincado.

### Strainer for assembling - flange PN 16

Constr.: in zinc plated steel.

Medida/Size	A	B	D
2"	80	155	110
2 1/2"	100	175	130
3"	125	200	145
4"	150	210	165
5"	180	240	195
6"	205	275	220
8"	255	330	275
10"	300	385	330

2451 09	2"	0,600	-
2451 10	2 1/2"	0,780	-
2451 11	3"	0,935	-
2451 12	4"	1,212	-
2451 13	5"	1,570	-
2451 14	6"	1,910	-
2451 16	8"	2,855	-
2451 18	10"	3,857	-

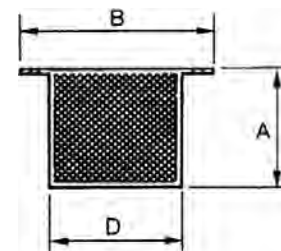

Ref. 2453



### Válvula retención a bola - bridas DIN PN 16

Cuerpo fundido hierro GGG-40. Esfera recubierta con NBR. Presión máx: 16 BAR. Temperatura: -10°C +80°C. Dimensiones entre caras según DIN 3202 F6.

### Check valve with ball - flanges DIN PN 16

Body and disk: cast iron GGG-40. Ball: with NBR coated. Max. pressure: 16 BAR. Temp.: -10°C +80°C. Dimensions between sides DIN 3202 F6.

Medida/Size	DN	PN	H	L
2"	50	16	106	200
2 1/2"	65	16	129	240
3"	80	16	146	260
4"	100	16	194	300
5"	125	16	207	350
6"	150	16	240	400
8"	200	16	322	500
10"	250	16	388	600

2453 09	2"	7,523	-
2453 10	2 1/2"	11,080	-
2453 11	3"	15,600	-
2453 12	4"	20,575	-
2453 13	5"	33,500	-
2453 14	6"	48,100	-
2453 16	8"	85,500	-
2453 18	10"	140,000	-

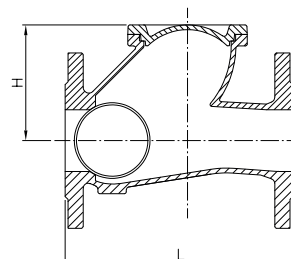



Ref. 2458G

**NEW**

**Filtro "Y" extremos bridados**

Construcción: Fundición GGG-40. Junta: PTFE+Grafito. Conexión: Bridas DIN PN 16. Presión de trabajo: 16 bar. Temp: -10°C + 120°C. Tamiz: AISI 304 chapa perforada (ver d1).

**Flanged ends "Y" Strainer**

Construction: Ductile Iron GGG-40. Gasket: PTFE+Graphite. Ends: Flanges DIN PN 16. Working pressure: 16 bar. Working temp: -10°C +120°C. Screen: AISI 304 perforated plate (see d1)



DN	A	D	L	d1
50	137	165	230	1,5
65	157	185	290	1,5
80	172	200	310	1,5
100	198	220	350	1,5
125	253	250	400	1,5
150	285	285	480	1,5
250	342	340	600	2
250	414	400	730	2
300	489	455	850	2

CÓDIGO CODE	MEDIDA SIZE	PESO WEIGHT	P.V.P. € PRICE €
2458G 08	1 1/2"	6,000	-
2458G 09	2"	8,000	-
2458G 10	2 1/2"	11,000	-
2458G 11	3"	13,000	-
2458G 12	4"	18,000	-
2458G 13	5"	26,000	-
2458G 14	6"	37,000	-
2458G 16	8"	56,000	-
2458G 18	10"	82,000	-
2458G 20	12"	118,000	-

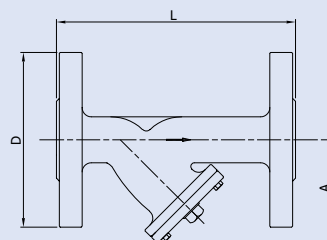

Ref. 2460 - 2460N

**Art. 2460N rosca NPT. Filtro - Y PN 40 - rosca gas**

Construcción: inox. CF8M (316) microfusión. Juntas: PTFE. Conexión: rosca gas ISO 7-1 (EN 10226-1). Presión de trabajo: 40 BAR. Temperatura: -30°C +240°C. Tamiz: AISI 316 chapa perforada (ver d1).

**"Y" strainer PN 40 (2460N - NPT thread)**

Constr. stainless steel CF8M (316) investment casting. Seat: PTFE; gas threaded end ISO 7-1 (EN 10226-1). Working pressure: 40 BAR. Temperature: -30°C +240°C. Screen: AISI 316 perforated plate (see d1).



DN	A	L	d1
1/4"	30	65	1
3/8"	30	65	1
1/2"	40	65	1
3/4"	45	80	1
1"	55	90	1
1 1/4"	65	105	1
1 1/2"	70	120	1
2"	85	140	1

2460 02	1/4"	0,200	-
2460 03	3/8"	0,174	-
2460 04	1/2"	0,203	-
2460 05	3/4"	0,324	-
2460 06	1"	0,582	-
2460 07	1 1/4"	0,776	-
2460 08	1 1/2"	1,057	-
2460 09	2"	1,623	-

Precios rosca NPT a consultar / NPT thread prices on request

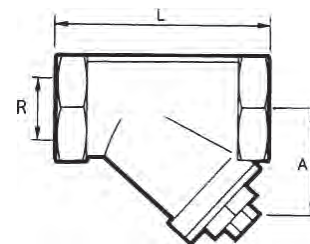

Ref. 2461

**Filtro - Y bridas DIN PN 16**

Construcción: AISI 316. Juntas: PTFE conexión: bridas DIN PN 16. Presión de trabajo: 16 BAR. Temp.: -30°C +240°C. Tamiz: AISI 316 chapa perforada (ver d1).

**Flanged "Y" strainer PN 16**

Constr. AISI 316. Gaskets: PTFE ends: flanges DIN PN 16. Working pressure: 16 BAR. Temperature: -30°C +240°C. Screen: AISI 316 perforated plate (see d1).



DN	A	D	L	d1
15	75	95	130	1
20	90	105	150	1
25	100	115	160	1
32	115	140	180	1
40	130	150	200	1
50	150	165	230	1
65	190	185	290	2
80	200	200	310	2
100	230	220	350	2
125	280	250	400	2
150	300	285	480	2
200	400	340	605	2

2461 04	1/2"	1,776	-
2461 05	3/4"	2,548	-
2461 06	1"	3,481	-
2461 07	1 1/4"	4,684	-
2461 08	1 1/2"	6,000	-
2461 09	2"	8,900	-
2461 10	2 1/2"	12,790	-
2461 11	3"	17,085	-
2461 12	4"	19,770	-
2461 13	5"	30,200	-
2461 14	6"	40,900	-
2461 16	8"	77,000	-

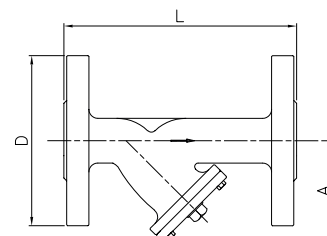

# LÍNEA INDUSTRIAL / INDUSTRIAL LINE

01 VÁLVULAS INDUSTRIALES INDUSTRIAL VALVES

Ref. 2461A



### Filtro - Y bridas ANSI B 16.5 S-150

Construcción: AISI 316. Juntas: PTFE. Conexión: bridas ANSI. Clase 150. Presión de trabajo: 19 kg/cm2. Temp.: -30°C +240°C. Tamiz: AISI 316 chapa perforada (ver d1).

### Strainer Y. Flanged ANSI B 16.5 S-150

Construction: AISI 316. Gasket: PTFE. Connection: flanged ANSI. Class 150. Working pressure: 19 kg/cm2. Temp.: -30°C +240°C. Screen: AISI 316 perforated plate (see d1). 275 Psi -22°F + 464°F

Medida/Size	A	D	L	d1
2"	155	152	210	1
2 1/2"	190	178	250	2
3"	200	190	280	2
4"	230	229	340	2
6"	325	279	415	2
8"	397	343	495	2

CÓDIGO CODE	MEDIDA SIZE	PESO WEIGHT	P.V.P. € PRICE €
2461A 09	2"	7,300	-
2461A 10	2 1/2"	11,350	-
2461A 11	3"	14,600	-
2461A 12	4"	23,200	-
2461A 14	6"	38,500	-
2461A 16	8"	69,400	-

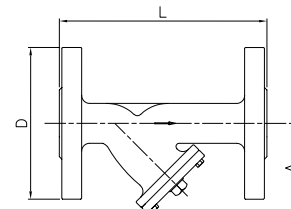

Ref. 2525



### Válvula esfera paso total 2 piezas bridas DIN PN 16

Montaje directo de actuadores S/ISO 5211. Cuerpo: fundición nodular GGG-40. Esfera y eje: AISI 304. Asientos: PTFE + 15% FV. Tórica eje: vitón. Presión máx.: 16 kg/cm2. Temp. -30°C +180°C. Mando manual por palanca con sistema de bloqueo. L: S/DIN 3202 F-4.

### 2 pcs. Full bore ball valve flanges DIN PN 16

Body: ductil iron GGG-40. Ball and stem: AISI 304. Seats: PTFE + 15% GF. Stem o'ring: viton. Max. pressure: 16 kg/cm2. Temp. -30°C +180°C. Manually operated by handle with locking system. L: S/DIN 3202 F-4.

Medida/Size	DN	D	L	M	A	ISO 5211
1/2"	15	95	115	130	80	F03/F04
3/4"	20	105	120	130	80	F03/F04
1"	25	115	125	170	90	F04/F05
1 1/4"	32	140	130	170	102	F04/F05
1 1/2"	40	150	140	220	110	F05/F07
2"	50	165	150	220	120	F05/F07
2 1/2"	65	185	170	284	140	F07/F10
3"	80	200	180	284	150	F07/F10
4"	100	220	190	360	180	F07/F10
5"	125	250	325	447	215	F07/F10
6"	150	285	350	560	240	F10/F12
8"	200	340	400	1000	320	F12/F14

2525 04	1/2"	2,350	-
2525 05	3/4"	2,950	-
2525 06	1"	3,920	-
2525 07	1 1/4"	5,530	-
2525 08	1 1/2"	7,399	-
2525 09	2"	9,377	-
2525 10	2 1/2"	13,900	-
2525 11	3"	18,183	-
2525 12	4"	25,933	-
2525 13	5"	36,320	-
2525 14	6"	48,900	-
2525 16	8"	95,700	-

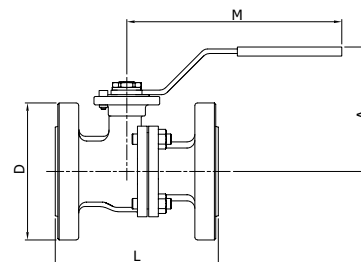

Ref. 2526A



### Válvula esfera paso total 2 piezas bridas ANSI B 16.5 S-150

Montaje directo de actuadores s/ISO 5211. Diseño fire safe. Dispositivo antiestático. Cuerpo: acero al carbono WCB (microfundición). Esfera y eje: AISI 316. Asientos: PTFE + 25 % Grafito. Tórica eje: vitón. Presión máx.: 19 kg/cm2. Temp. -30°C +220°C. Mando manual por palanca con sistema de bloqueo.

### 2 pcs. Full bore ball valve flanges ANSI B 16.5 S-150

Direct mounting for actuators s/ISO 5211. Fire safe design. Antistatic device. Body: carbon steel WCB (investment casting). Ball and stem: AISI 316. Seats: PTFE + 25 % Graphite. Stem o'ring: viton. Max. pressure: 19 kg/cm2. Temp. -30°C +220°C. Manually operated by handle with locking system. 275 Psi -22°F + 356°F

Medida/Size	DN	D	L	M	A	ISO 5211
1/2"	15	89	108	165	90	F04
3/4"	20	98,6	117	165	95	F04/F05
1"	25	108	127	165	95	F04/F05
1 1/4"	32	117	140	165	106	F05/F07
1 1/2"	40	127	165	200	110	F05/F07
2"	50	152,5	178	200	118	F05/F07
2 1/2"	65	177,8	190	400	160	F07/F10
3"	80	190,5	203	400	170	F07/F10
4"	100	228,6	229	400	186	F07/F10
6"	150	279,4	394	800	280	F10/F12

2526A 04	1/2"	1,533	-
2526A 05	3/4"	1,944	-
2526A 06	1"	2,706	-
2526A 07	1 1/4"	4,055	-
2526A 08	1 1/2"	5,509	-
2526A 09	2"	8,124	-
2526A 10	2 1/2"	15,097	-
2526A 11	3"	18,813	-
2526A 12	4"	31,000	-
2526A 14	6"	57,000	-

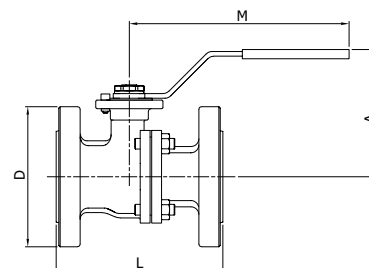

**Ref. 2528**



**Válvula esfera paso total 2 piezas diseño "fire safe" montaje directo de actuadores S/ISO 5211.**  
**Bridas DIN PN -40 ≤ DN -50**  
**Bridas DIN PN -16 >DN -50**  
 Cuerpo: inox. CF8M (316) microfundición.  
 Asientos y juntas: PTFE +15% FV tórica eje: vitón.  
 Dispositivo antiestático. Presión máx.: 40/16 BAR según medida.  
 Temp.: -30°C +180°C. Mando manual por palanca.  
 Long: S/DIN 3202 F-4 DN 15 DN 100 F-5 DN 125 DN 200.

**2 pcs full bore ball valve fire-safe design direct mounting for actuators ISO 5211.**  
**Flanges DIN PN -40 ≤ DN -50**  
**Flanges DIN PN -16 >DN -50**  
 Body: Stainless steel. CF8M (316) investment casting.  
 Seats: PTFE + 15% GF stem o'ring: viton. Antistatic device.  
 Max. pressure: 40/16 BAR depending on size.  
 Temp.: -30°C +180°C. manually operated by handle.  
 L: DIN 3202 F-4 DN 15 DN 100 F-5 DN 125 DN 200.

Medida/Size	PN	Dimensiones/Dimensions mm				ISO 5211
		D	A	L	M	
1/2"	40	95	85	115	170	F04
3/4"	40	105	85	120	170	F04/F05
1"	40	116	95	125	170	F04/F05
1 1/4"	40	140	106	130	200	F05/F07
1 1/2"	40	150	110	140	200	F05/F07
2"	40	165	118	150	200	F05/F07
2 1/2"	16	185	157	170	380	F07/F10
3"	16	200	170	180	380	F07/F10
4"	16	220	184	190	380	F07/F10
5"	16	250	200	325	520	F10/F12
6"	16	285	220	350	620	F10/F12
8"	16	340	334	400	800	F12

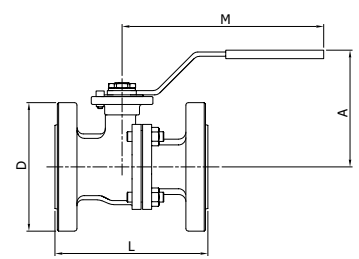

CÓDIGO CODE	MEDIDA SIZE	PESO WEIGHT	P.V.P. € PRICE €
2528 04	1/2"	2,190	-
2528 05	3/4"	3,020	-
2528 06	1"	3,840	-
2528 07	1 1/4"	5,859	-
2528 08	1 1/2"	6,913	-
2528 09	2"	9,481	-
2528 10	2 1/2"	15,090	-
2528 11	3"	19,261	-
2528 12	4"	27,055	-
2528 13	5"	38,000	-
2528 14	6"	51,000	-
2528 16	8"	120,000	-

**Ref. 2528A**



**Válvula esfera paso total 2 piezas diseño "fire safe" bridas ANSI B-16.5 S-150 montaje directo de actuadores S/ISO 5211**  
 Cuerpo: inox. CF8M (316). Asientos: PTFE +15% FV. Presión máx.: 19 kg/cm2.  
 Temp.: -30°C +180°C. Mando manual por palanca.

**2 pcs full bore ball valve fire safe design flanges ANSI B-16.5 s-150. Direct mounting for actuators ISO 5211**  
 Body: stainless steel CF8M (316). Seats: PTFE + 15% GF. Max. pressure: 19 kg/cm2. Temp.: -30°C +180°C. Manually operated by handle.  
 275 Psi -22°F + 356°F

Medida/Size	DN	D	L	M	A	ISO 5211
1/2"	15	89	108	165	85	F04
3/4"	20	98,6	117	165	85	F04/F05
1"	25	108	127	200	95	F04/F05
1 1/4"	32	117	140	165	106	F05/F07
1 1/2"	40	127	165	200	110	F05/F07
2"	50	152,5	178	200	118	F05/F07
2 1/2"	65	177,8	190	380	157	F07/F10
3"	80	190,5	203	380	170	F07/F10
4"	100	228,6	229	380	184	F07/F10
6"	150	279,4	394	620	225	F10/F12
8"	200	342,9	457	800	330	F12

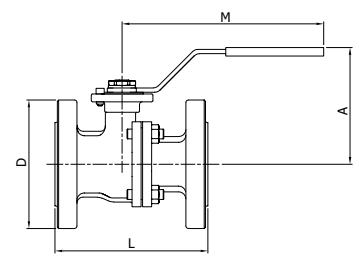

2528A 04	1/2"	1,515	-
2528A 05	3/4"	1,938	-
2528A 06	1"	2,679	-
2528A 07	1 1/4"	4,063	-
2528A 08	1 1/2"	5,452	-
2528A 09	2"	8,016	-
2528A 10	2 1/2"	15,015	-
2528A 11	3"	18,808	-
2528A 12	4"	31,000	-
2528A 14	6"	57,000	-
2528A 16	8"	128,800	-

**Ref. 2529**



**Válvula esfera paso total 2 piezas diseño "fire safe" bridas DIN PN-40 montaje directo de actuadores según ISO 5211**  
 Cuerpo: CF8M (316). Asientos y juntas: PTFE +15% FV. Tórica eje: vitón.  
 Presión máx.: 40 BAR. Temp.: -30°C +180°C. Mando manual por palanca. L: S/DIN 3202 F-4 DN 65 DN 100. F-5 DN 125 DN 200.

**2 pcs. Full bore ball valve "fire safe" design flanges DIN PN-40 direct mounting for actuators ISO 5211**  
 Body: stainless steel. CF8M (316). Seats: PTFE + 15% GF. Stem o'ring: viton.  
 Max. pressure: 40 BAR. temp.: -30°C +180°C. Manually operated by handle. L: DIN 3202 F-4 DN 65 DNO 100. F-5 DN 125 DN 200.

Medida/Size	DN	L	D	A	M	ISO 5211
2 1/2"	65	170	185	157	380	F07/F10
3"	80	180	200	170	380	F07/F10
4"	100	190	235	184	380	F07/F10
5"	125	325	270	200	380	F10/F12
6"	150	350	300	350	450	F07/F10

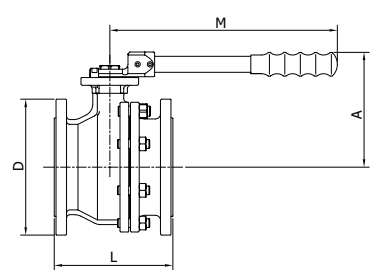

2529 10	2 1/2"	15,950	-
2529 11	3"	20,560	-
2529 12	4"	29,400	-
2529 13	5"	52,900	-
2529 14	6"	66,000	-

# LÍNEA INDUSTRIAL / INDUSTRIAL LINE

01 VÁLVULAS INDUSTRIALES INDUSTRIAL VALVES

Ref. 2540E - 2541E

**NEW**



**Válvula de esfera 3 vías paso total 2540E paso tipo "L" / 2541E paso tipo "T"**  
**Bridas DIN PN 40 DN50**  
**Bridas DIN PN 16 > DN50**  
 Montaje directo de actuadores s/ISO 5211.  
 Cuerpo: inox CF8M (316). 4 asientos: PTFE + 15% FV.  
 Presión máx. 16/40 BAR según medida.  
 Temp.: -30°C +180°C. Mando manual por palanca.

**3 ways full bore ball valve 2540E "L" bore / 2541E "T" bore**  
**Flanges DIN PN 40 DN50**  
**Flanges DIN PN 16 > DN50**  
 Direct mounting for actuators ISO 5211.  
 Body: stainless steel CF8M (316). 4 seats: PTFE + 15% GF.  
 Max. pressure: 16/40 BAR depending on size.  
 Temp.: -30°C +180°C. Manually operated by handle.

Medida/Size	PN	P	D	L	M
1"	40	25	115	180	163
1 1/4"	40	32	140	190	209
1 1/2"	40	40	150	212	209
2"	40	50	165	230	209
2 1/2"	16	65	185	290	450
3"	16	80	200	310	500
4"	16	100	220	350	550

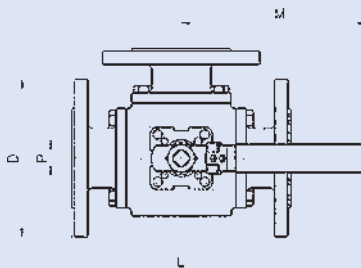

CÓDIGO CODE	MEDIDA SIZE	PESO WEIGHT	P.V.P. € PRICE €
<b>2540E / 2541E</b>			
XXXX 06	1"	7,360	-
XXXX 07	1 1/4"	10,420	-
XXXX 08	1 1/2"	14,260	-
XXXX 09	2"	18,220	-
XXXX 10	2 1/2"	27,300	-
XXXX 11	3"	39,100	-
XXXX 12	4"	59,640	-

Ref. 2544 - 2545

**NEW**



**Válvula esfera 3 vías paso total. 2544 paso tipo "L" / 2545 paso tipo "T".** **Bridas DIN PN40 DN50. Bridas DIN PN16 DN50.**  
 Montaje directo de actuadores s/ISO 5211.  
 Cuerpo: Acero al Carbono 1.0619 (WCB) microfundición.  
 Esfera acero inox. 316. Asientos PTFE.  
 Presión máx. 16/40 bar según medida.  
 Temp.: -25°C +180°C. Mando manual por palanca con sistema de bloqueo.

**3 way full bore ball valve. 2544 "L" bore / 2545 "T" bore.**  
**Flanges DIN PN40 DN50. Flanges DIN PN16 DN50.**  
 Direct mounting for actuators ISO 5211.  
 Body: Carbon steel 1.0619 (WCB) investment casting.  
 Ball: AISI 316. Ball seats: PTFE.  
 Máx. Pressure: 16/40 bar depending on size.  
 Temp.: -25°C +180°C. Manually operated by handle with locking system.

Medida/Size	PN	P	D	L	M
1"	40	25	115	180	163
1 1/4"	40	32	140	190	209
1 1/2"	40	40	150	212	209
2"	40	50	165	230	209
2 1/2"	16	65	185	290	450
3"	16	80	200	310	500
4"	16	100	220	350	550

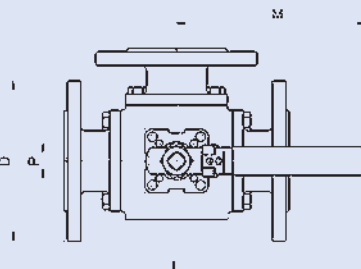

CÓDIGO CODE	MEDIDA SIZE	PESO WEIGHT	P.V.P. € PRICE €
<b>2544 / 2545</b>			
XXXX 06	1"	7,360	-
XXXX 07	1 1/4"	10,420	-
XXXX 08	1 1/2"	14,260	-
XXXX 09	2"	18,400	-
XXXX 10	2 1/2"	27,300	-
XXXX 11	3"	39,100	-
XXXX 12	4"	59,640	-

Ref. 2830 - 2830N



**Manguito elástico - doble onda (2830N - Rosca NPT)**  
 Rosca gas, también disponible en rosca NPT (2830N).  
 Cuerpo EPDM, extremos racors. Roscas gas galvanizados.  
 Presión de trabajo máx.: 10 BAR. Temp. -10°C +105°C.  
 Longitud: 200 mm.

**Rubber expansion joint-double wave (2830N - NPT thread)**  
 Gas thread, also available npt thread (2830N).  
 Body EPDM. Galvanised gas threaded ends.  
 Max. working pressure: 10 BAR. Temp. -10°C +105°C.  
 Length: 200 mm.

Medida/Size	L
3/4"	200
1"	200
1 1/4"	200
1 1/2"	200
2"	200
2 1/2"	245
3"	245

CÓDIGO CODE	MEDIDA SIZE	PESO WEIGHT	P.V.P. € PRICE €
2830 05	3/4"	0,620	-
2830 06	1"	1,020	-
2830 07	1 1/4"	1,290	-
2830 08	1 1/2"	1,760	-
2830 09	2"	2,510	-
2830 10	2 1/2"	3,633	-
2830 11	3"	5,300	-

Precios rosca NPT a consultar / NPT thread prices on request

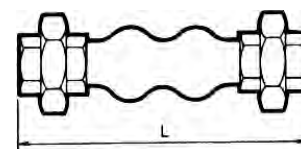

Ref. 2831

**Manguito elástico - simple onda**

Cuerpo EPDM. Bridas DIN PN 10 zincadas. Presión de trabajo. Máx.: 10 BAR. Temp: -10°C +105°C.

**Rubber expansion - joint-single wave**

Body: EPDM. Zinc plated DIN PN 10 flanges. Max. working pressure: 10 BAR. Temp. -10°C +105°C.



DN	P	L	D	D1
32	40	95	140	69
40	40	95	150	69
50	52	105	165	86
65	68	115	185	106
80	76	130	200	116
100	103	135	220	150
125	128	170	250	180
150	152	180	285	209
200	194	195	340	260
250	250	240	395	320
300	300	260	445	367
350	320	255	505	408
400	372	255	565	472
450	415	255	615	522
500	454	255	670	570

CÓDIGO CODE	MEDIDA SIZE	PESO WEIGHT	P.V.P. € PRICE €
2831 07	1 1/4"	2,870	-
2831 08	1 1/2"	3,375	-
2831 09	2"	3,990	-
2831 10	2 1/2"	5,090	-
2831 11	3"	6,160	-
2831 12	4"	6,640	-
2831 13	5"	9,400	-
2831 14	6"	12,630	-
2831 16	8"	17,050	-
2831 18	10"	22,300	-
2831 20	12"	26,500	-
2831 22	14"	36,700	-
2831 24	16"	44,300	-
2831 26	18"	46,800	-
2831 28	20"	57,500	-

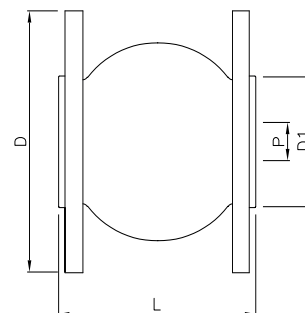

Ref. 2831A

**Manguito elástico bridas**

Cuerpo EPDM. Bridas ANSI 150 lbs zincadas. Presión de trabajo máx.: 19 kg/cm2. Temp: -10°C +105°C.

**Rubber expansion joint**

Body: EPDM. Zinc plated ANSI 150 lbs flanges. Max. working pressure: 19 kg/cm2. Temp.: -10°C +105°C.

275 Psi -14°F + 221°F



Medida/Size	P	L	D	D1
1 1/4"	40	95	117,5	69
1 1/2"	40	95	127	69
2"	52	105	152,4	86
2 1/2"	68	115	177,8	106
3"	76	130	190,5	116
4"	103	135	228,6	150
5"	128	170	254	180
6"	152	180	279,4	209
8"	194	205	342,9	260
10"	250	240	406,4	320
12"	300	260	482,6	367
14"	320	255	533,4	408
16"	372	255	596,9	472
18"	415	255	635	522
20"	454	255	698,5	570

CÓDIGO CODE	MEDIDA SIZE	PESO WEIGHT	P.V.P. € PRICE €
2831A 07	1 1/4"	1,750	-
2831A 08	1 1/2"	2,300	-
2831A 09	2"	3,350	-
2831A 10	2 1/2"	4,350	-
2831A 11	3"	5,783	-
2831A 12	4"	7,470	-
2831A 13	5"	9,525	-
2831A 14	6"	11,900	-
2831A 16	8"	17,500	-
2831A 18	10"	23,800	-
2831A 20	12"	37,150	-
2831A 22	14"	50,200	-
2831A 24	16"	57,000	-
2831A 26	18"	55,420	-
2831A 28	20"	69,050	-

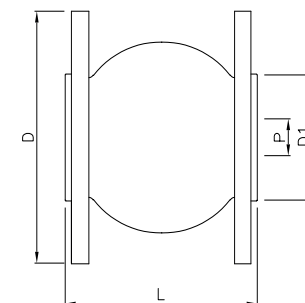

# LÍNEA INDUSTRIAL / INDUSTRIAL LINE

Ref. 2833



**Manguito elástico - doble onda EPDM**

Cuerpo EPDM. Bridas DIN PN-10 zincadas.  
Presión trabajo máx: 10 BAR. Temp: -10°C +105°C

**Rubber expansion joint-double wave EPDM**

Body: EPDM, zinc plated DIN 10 flanges.  
Max. working pressure: 10 BAR. Temp.: -10°C +105°C.

DN	P	L	D	D1
50	52	175	165	86
65	68	175	185	106
80	76	175	200	116
100	103	225	220	150
125	128	225	250	180
150	152	225	285	209
200	194	325	340	260
250	250	325	395	320
300	300	325	445	367

CÓDIGO CODE	MEDIDA SIZE	PESO WEIGHT	P.V.P. € PRICE €
2833 09	2"	4,315	-
2833 10	2 1/2"	5,200	-
2833 11	3"	6,100	-
2833 12	4"	7,275	-
2833 13	5"	9,700	-
2833 14	6"	13,100	-
2833 16	8"	17,000	-
2833 18	10"	23,150	-
2833 20	12"	30,050	-

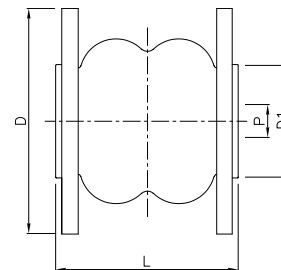

Ref. 2834



**Junta de expansión metálica con camisa interior**

Extremos soldar, PN 10. Fuelle acero inox. AISI 304. Camisa interior acero inox. AISI 304. Extremos acero inox. AISI 304. Temp. máx.: 300°C.

**Metal expansion joint with internal liner**

Welded ends, PN 10. Internal liner bellows: stainless steel AISI 304. Stainless steel AISI 304 ends. Max. temp. 300°C.

Medida/Size	L	Do	De
1 1/2"	200	52	48,3
2"	275	69	60,3
2 1/2"	275	88	76,1
3"	275	107	88,9
4"	300	140	114,3
5"	300	167	139,7
6"	350	199	168,3
8"	350	266	219,1

2834 08	1 1/2"	0,682	-
2834 09	2"	1,365	-
2834 10	2 1/2"	1,550	-
2834 11	3"	1,600	-
2834 12	4"	3,375	-
2834 13	5"	4,090	-
2834 14	6"	6,900	-
2834 16	8"	10,800	-

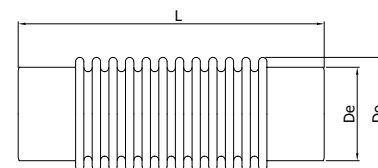

Ref. 2835E



**Junta de expansión metálica con camisa interior**

Extremos bridas DIN PN 16. Fuelle acero inox. AISI 304. Camisa interior acero inox. AISI 304. Extremos bridas en acero carbono. Presión máx. trabajo: 16 bar. Temp. máx.: 300°C.

**Metal expansion joint with internal liner**

Flanged ends DIN PN 16. Internal liner, bellows and ends: stainless steel AISI 304. Max. working pressure: 16 bar. Max. temp. 300°C.

DN	L	Do	K	D
25	170	45	85	115
32	170	45	100	140
40	170	45	110	150
50	170	69	125	165
65	170	88	145	185
80	170	107	160	200
100	170	140	180	220
125	170	167	210	250
150	220	199	240	285
200	220	266	295	340

CÓDIGO CODE	MEDIDA SIZE	PESO WEIGHT	CAJA / BOX CARTON	P.V.P. € PRICE €
2835E 06	1"	2,333	-	-
2835E 07	1 1/4"	3,900	-	-
2835E 08	1 1/2"	3,900	-	-
2835E 09	2"	6,100	-	-
2835E 10	2 1/2"	7,950	-	-
2835E 11	3"	10,100	-	-
2835E 12	4"	10,770	-	-
2835E 13	5"	14,630	-	-
2835E 14	6"	20,400	-	-
2835E 16	8"	30,400	-	-

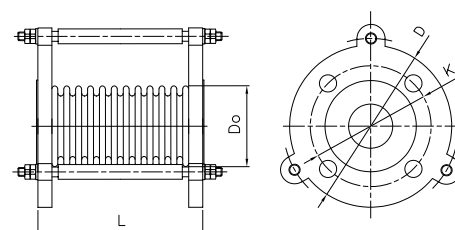

Ref. **2835AE**



**Junta de expansión metálica con camisa interior**  
 Extremos bridas ANSI 150lbs. Fuelle acero INOX. AISI 304. Camisa interior acero inox. AISI 304. Extremos bridas en acero carbono. Presión máx. trabajo: 19 kg/cm2. Temp. máx.: 300°C.

**Metal expansion joint with internal liner**  
 Flanged ends carbon plated steel ANSI 150 lbs. Internal liner bellows: stainless steel AISI 304. Max. working pressure: 19 kg/cm2. Max. temp. 300°C.

Medida/Size	L	Do	K	D
2"	170	69	120,6	152,4
2 1/2"	170	88	139,7	177,8
3"	170	107	152,4	190,5
4"	170	140	190,5	228,6
5"	170	167	215,4	254
6"	220	199	241,3	279,4
8"	220	266	298,4	342,9

CÓDIGO CODE	MEDIDA SIZE	PESO WEIGHT	CAJA / BOX CARTON	P.V.P. € PRICE €
-------------	-------------	-------------	-------------------	------------------

2835AE 09	2"	5,800	-	-
2835AE 10	2 1/2"	10,150	-	-
2835AE 11	3"	11,500	-	-
2835AE 12	4"	13,633	-	-
2835AE 13	5"	21,400	-	-
2835AE 14	6"	21,200	-	-
2835AE 16	8"	31,100	-	-

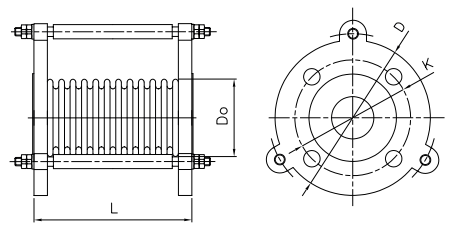

Ref. **2848**



**Controlador de flujo (líquidos)**  
 Caja aleación aluminio. Racor latón. Lengüetas en acero inox. Para tuberías de 1" a 8". Conexión rosca 1" ISO 7/1 (EN 10226-1). Temp. máx. 110°C. Presión máx. 10 bar. 250V - 10A. Protección IP-64.

**Liquid flow switch**  
 Aluminium alloyed box. Brass connector. Blade: stainless steel for pipe from 1" to 8". Threaded connection 1" ISO 7/1 (EN 10226-1). Max. temp. 110°C. Max. pressure 10 bar. 250V - 10A. Protection IP-64.

2848 06	1"	0,625	1-10	-
---------	----	-------	------	---

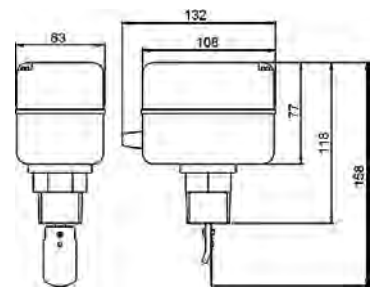

Ref. **2850**



**Controlador de flujo (líquidos)**  
 Caja acero pintado - racor latón. Lengüetas en acero inox. Para tuberías de 1" a 8". Conexión rosca 1" ISO 7/1 (EN 10226-1). Temp. máx. 110°C. Presión máx. 10 bar. 250V - 10A. Protección IP-54.

**Liquid flow switch**  
 Coated steel box. Brass connector. Blade: stainless steel for pipe from 1" to 8". Threaded connection 1" ISO 7/1 (EN 10226-1). Max. temp. 110°C. Max. pressure 10 bar. 250V - 10A. Protection: IP 54.

2850 06	1"	0,650	1-10	-
---------	----	-------	------	---

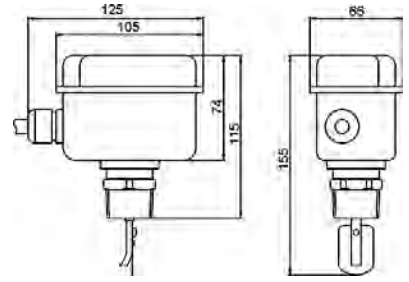

Ref. **3886**



**Válvula de flotador sin boya**  
 Construcción en acero inoxidable AISI 304. Conexión rosca gas. Paso total. Cierre de silicona. Presión de trabajo máxima 10 BAR. Máx. temp. trabajo 150°.

**Floating valve without buoy**  
 Made of stainless steel AISI 304. Connection gas threaded. Full port. Silicone sealing. Max. working pressure 10 BAR. Máx working temp. 150°.

R	L	A
3/8"	300	32
1/2"	410	35
3/4"	500	42
1"	580	45
1 1/4"	580	52

3886 03	3/8"	0,010	10 *-20	-
3886 04	1/2"	0,182	10 *-20	-
3886 05	3/4"	0,294	10 *-15	-
3886 06	1"	0,371	5 *-10	-
3886 07	1 1/4"	0,440	5 *-10	-

\* Cantidad mínima de venta / \* Minimum sale quantity

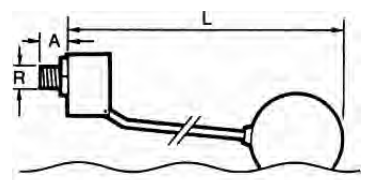

# LÍNEA INDUSTRIAL / INDUSTRIAL LINE

01 VÁLVULAS INDUSTRIALES INDUSTRIAL VALVES

Ref. 3887



**Boya para flotador**

Construcción en acero inoxidable AISI 304.

**Buoy for floating valves**

Made of stainless steel AISI 304.

R	D	M
3/8"	90	M-6
1/2"	110	M-6
3/4"	160	M-8
1"	160	M-8
1 1/4"	160	M-8

CÓDIGO CODE	MEDIDA SIZE	PESO WEIGHT	CAJA / BOX CARTON	P.V.P. € PRICE €
-------------	-------------	-------------	-------------------	------------------

3887 090	Ø 90 mm	0,066	1-48	-
3887 110	Ø 110 mm	0,100	1-27	-
3887 160	Ø 160 mm	0,340	1-8	-

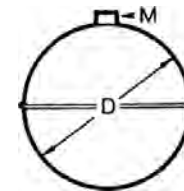

Ref. 2856



**Válvula de flotador sin boya (2856N - rosca NPT)**

Construcción: inox. AISI 316. Cierre silicona. Presión máx.: 10 BAR.  
 Conexión: DN 10 - DN65: rosca gas ISO 228/1 y DN80 - DN100: Brida DIN 2576PN 10/16  
 Bridas ANSI a consultar.

**Floating valve (2856N - NPT thread)**

Constr. stainless steel AISI 316. Silicone sealing. Max. pressure: 10 BAR.  
 Connection DN10 - DN65 gas ISO 228/1 thread  
 DN80 - DN100 flange DIN 2576 PN 10/16  
 Flage ANSI on request.

Medida/Size	L	A
3/8"	300	32
1/2"	410	35
3/4"	500	42
1"	580	45
1 1/4"	580	52
1 1/2"	620	60
2"	720	70
2 1/2"	720	80
3"	1110	105
4"	1160	105

2856 03	3/8"	0,350	1	-
2856 04	1/2"	0,330	1-75	-
2856 05	3/4"	0,530	1-36	-
2856 06	1"	0,588	1-10	-
2856 07	1 1/4"	0,737	1-10	-
2856 08	1 1/2"	2,710	1-8	-
2856 09	2"	2,890	1-6	-
2856 10	2 1/2"	3,050	1-6	-
2856 11	3"	18,950	-	-
2856 12	4"	20,500	-	-

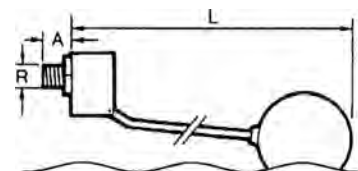

Ref. 2852



**Boya para flotador - inox. 316**

**Buoy for floating valve stainless steel 316**

Medida/Size	D	M
3/8"	90	M-6
1/2"	110	M-6
3/4"	160	M-8
1"	160	M-8
1 1/4"	160	M-8
1 1/2"	200	M-12
2"	200	M-12
2 1/2"	200	M-12
3"	320	M-16
4"	400	M-16

2852 060	-	0,055	1-1	-
2852 090	3/8"	0,150	1-1	-
2852 110	1/2"	0,150	1-27	-
2852 160	3/4"	0,420	1-8	-
2852 160	1"	0,420	1-8	-
2852 160	1 1/4"	0,420	1-8	-
2852 200	1 1/2"	0,810	1-8	-
2852 200	2"	0,810	1-8	-
2852 200	2 1/2"	0,810	1-8	-
2852 300	3"	2,800	-	-
2852 400	4"	4,850	-	-

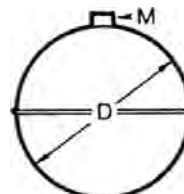





# VÁLVULAS CON ESFERAS VARIABLE

## VARIABLE BALL VALVES

Configuración de esfera en "V": 30º -60º -90º  
Configuration of "V" ball:30º -60º -90º



CÓDIGO CODE	MEDIDA SIZE	PESO WEIGHT	P.V.P. € PRICE €
----------------	----------------	----------------	---------------------

Ref. 2015V



**Válvula de control con esfera "V", 2 piezas**  
Características de válvula ver art. 2015  
Solicitar ángulo necesario 30º, 60º o 90º; ver extensión XX en cuadro.  
**"V" control ball valve, 2 pieces**  
Valve characteristics see art. 2015  
Indicate necessary angle 30º, 60º or 90º; see extension XX.

2015V XX 04	XX= 30º/60º/90º	-	-
2015V XX 05	XX= 30º/60º/90º	-	-
2015V XX 06	XX= 30º/60º/90º	-	-
2015V XX 07	XX= 30º/60º/90º	-	-
2015V XX 08	XX= 30º/60º/90º	-	-
2015V XX 09	XX= 30º/60º/90º	-	-

XX= Indicar ángulo necesario / Indicate necessary angle

Ref. 2025V - 2026V - 2027V



**Válvula de control con esfera "V", 3 piezas**  
Características de válvula ver art. 2025/2026/2027  
Solicitar ángulo necesario 30º, 60º o 90º; ver extensión XX en cuadro.  
**"V" control ball valve, 3 pieces**  
Valve characteristics see art. 2025/2026/2027  
Indicate necessary angle 30º, 60º or 90º; see extension XX.

2025V XX 04	XX= 30º/60º/90º	-	-
2025V XX 05	XX= 30º/60º/90º	-	-
2025V XX 06	XX= 30º/60º/90º	-	-
2025V XX 07	XX= 30º/60º/90º	-	-
2025V XX 08	XX= 30º/60º/90º	-	-
2025V XX 09	XX= 30º/60º/90º	-	-
2025V XX 10	XX= 30º/60º/90º	-	-
2025V XX 11	XX= 30º/60º/90º	-	-
2025V XX 12	XX= 30º/60º/90º	-	-

XX= Indicar ángulo necesario / Indicate necessary angle

Ref. 2526AV



**Válvula de control con esfera "V", 2 piezas bridas ANSI S-150**  
Características de válvula ver art. 2526A  
Solicitar ángulo necesario 30º, 60º o 90º; ver extensión XX en cuadro.  
**"V" control ball valve, 2 pieces flanges ends ANSI S-150**  
Valve characteristics see art. 2526A

2526AV XX 04	XX= 30º/60º/90º	-	-
2526AV XX 05	XX= 30º/60º/90º	-	-
2526AV XX 06	XX= 30º/60º/90º	-	-
2526AV XX 07	XX= 30º/60º/90º	-	-
2526AV XX 08	XX= 30º/60º/90º	-	-
2526AV XX 09	XX= 30º/60º/90º	-	-
2526AV XX 10	XX= 30º/60º/90º	-	-
2526AV XX 11	XX= 30º/60º/90º	-	-
2526AV XX 12	XX= 30º/60º/90º	-	-

XX= Indicar ángulo necesario / Indicate necessary angle

# LÍNEA INDUSTRIAL / INDUSTRIAL LINE

Ref. 2528V



**Válvula de control con esfera "V", 2 piezas bridas DIN PN 40/16**

Características de válvula ver art. 2528  
Solicitar ángulo necesario 30º, 60º o 90º; ver extensión XX en cuadro.

**"V" control ball valve, 2 pieces flanges ends DIN PN 40/16**

Valve characteristics see art. 2528  
Indicate necessary angle 30º, 60º or 90º; see extension XX.

CÓDIGO CODE	MEDIDA SIZE	PESO WEIGHT	P.V.P. € PRICE €
2528V XX 04	XX= 30º/60º/90º	-	-
2528V XX 05	XX= 30º/60º/90º	-	-
2528V XX 06	XX= 30º/60º/90º	-	-
2528V XX 07	XX= 30º/60º/90º	-	-
2528V XX 08	XX= 30º/60º/90º	-	-
2528V XX 09	XX= 30º/60º/90º	-	-
2528V XX 10	XX= 30º/60º/90º	-	-
2528V XX 11	XX= 30º/60º/90º	-	-
2528V XX 12	XX= 30º/60º/90º	-	-

XX= Indicar ángulo necesario / Indicate necessary angle

Ref. 2528AV



**Válvula de control con esfera "V", 2 piezas bridas ANSI S-150**

Características de válvula ver art. 2528A  
Solicitar ángulo necesario 30º, 60º o 90º; ver extensión XX en cuadro.

**"V" control ball valve, 2 pieces flanges ends ANSI S-150**

Valve characteristics see art. 2528A  
Indicate necessary angle 30º, 60º or 90º; see extension XX.

2528AV XX 04	XX= 30º/60º/90º	-	-
2528AV XX 05	XX= 30º/60º/90º	-	-
2528AV XX 06	XX= 30º/60º/90º	-	-
2528AV XX 07	XX= 30º/60º/90º	-	-
2528AV XX 08	XX= 30º/60º/90º	-	-
2528AV XX 09	XX= 30º/60º/90º	-	-
2528AV XX 10	XX= 30º/60º/90º	-	-
2528AV XX 11	XX= 30º/60º/90º	-	-
2528AV XX 12	XX= 30º/60º/90º	-	-

XX= Indicar ángulo necesario / Indicate necessary angle



## EXTENSOR PARA VÁLVULA MANUAL EXTENSION FOR MANUAL VALVE



Ref. 5330



**Extensor para válvula manual (\*)**  
 (\*) Válvula no incluida (consultar modelo de válvula)

**Extension for manual valve (\*)**  
 (\*) Valve not included (consult the model of the valve)

Válvulas roscar - soldar / Threaded - welded valves		
Ref.	ART.2015 - 2025 - 2026 - 2027	ART.2040 - 2041
5330 09 XXX	1/4" - 1/2"	1/4" - 1/2"
5330 11 XXX	3/4" - 1"	3/4" - 1"
5330 14 XXX	1 1/4" - 2"	1 1/4" - 2"
5330 17 XXX	2 1/2" - 4"	*****
5330 20 XXX	*****	2 1/2"

Válvulas bridadas / Flanged valves				
Ref.	ART.2118 - 2119	ART.2526A - 2528 - 2528A - 2529	ART.2525	ART.2540E - 2541E - 2544 - 2545
5330 09 XXX	1/2" - 3/4"	1/2" - 3/4"	1/2" - 3/4"	*****
5330 11 XXX	1" - 1 1/4"	1"	1" - 1 1/4"	1"
5330 14 XXX	1 1/2" - 2"	1 1/4" - 2"	1 1/2" - 2"	1 1/4" - 2"
5330 15 XXX	*****	*****	2 1/2" - 4"	*****
5330 17 XXX	*****	2 1/2" - 4"	*****	*****
5330 20 XXX	2 1/2" - 4"	*****	*****	2 1/2" - 4"

CÓDIGO CODE	MEDIDA SIZE	PESO WEIGHT	P.V.P. € PRICE €
L = 50mm			
5330 09 050	L=50 mm	0,130	-
5330 11 050	L= 50 mm	0,200	-
5330 14 050	L= 50mm	0,280	-
5330 15 050	L= 50mm	0,350	-
5330 17 050	L= 50mm	0,350	-
5330 20 050	L= 50mm	0,350	-
L = 100mm			
5330 09 100	L= 100 mm	0,245	-
5330 11 100	L= 100mm	0,380	-
5330 14 100	L= 100mm	0,540	-
5330 15 050	L= 100mm	0,800	-
5330 17 100	L= 100mm	0,800	-
5330 20 100	L= 100mm	0,800	-

Ref. 5332



**Extensor para válvula manual con sistema de bloqueo (\*)**  
 (\*) Válvula no incluida (consultar modelo de válvula)

**Extension for manual valve with locking system (\*)**  
 (\*) Valve not included (consult the model of the valve)

Válvulas roscar - soldar / Threaded - welded valves		
Ref.	ART.2015 - 2025 - 2026 - 2027	ART.2040 - 2041
5332 09 XXX	1/4" - 1/2"	1/4" - 1/2"
5332 11 XXX	3/4" - 1"	3/4" - 1"
5332 14 XXX	1 1/4" - 2"	1 1/4" - 2"
5332 17 XXX	2 1/2" - 4"	*****
5332 20 XXX	*****	2 1/2"

Válvulas bridadas / Flanged valves				
Ref.	ART.2118-2119	ART.2526A - 2528 - 2528A - 2529	ART.2525	ART.2540E - 2541E - 2544 - 2545
5332 09 XXX	1/2" - 3/4"	1/2" - 3/4"	1/2" - 3/4"	*****
5332 11 XXX	1" - 1 1/4"	1"	1" - 1 1/4"	1"
5332 14 XXX	1 1/2" - 2"	1 1/4" - 2"	1 1/2" - 2"	1 1/4" - 2"
5332 15 XXX	*****	*****	2 1/2" - 4"	*****
5332 17 XXX	*****	2 1/2" - 4"	*****	*****
5332 20 XXX	2 1/2" - 4"	*****	*****	2 1/2" - 4"

CÓDIGO CODE	MEDIDA SIZE	PESO WEIGHT	P.V.P. € PRICE €
L = 50mm			
5332 09 050	L=50 mm	0,200	-
5332 11 050	L= 50 mm	0,230	-
5332 14 050	L= 50mm	0,370	-
5332 15 050	L= 50mm	0,450	-
5332 17 050	L= 50mm	0,450	-
5332 20 050	L= 50mm	0,450	-
L = 100mm			
5332 09 100	L= 100 mm	0,360	-
5332 11 100	L= 100mm	0,430	-
5332 14 100	L= 100mm	0,680	-
5332 15 100	L= 100mm	0,850	-
5332 17 100	L= 100mm	0,850	-
5332 20 100	L= 100mm	0,850	-